

# SCHITA ASAMBLARE STENDER E-556

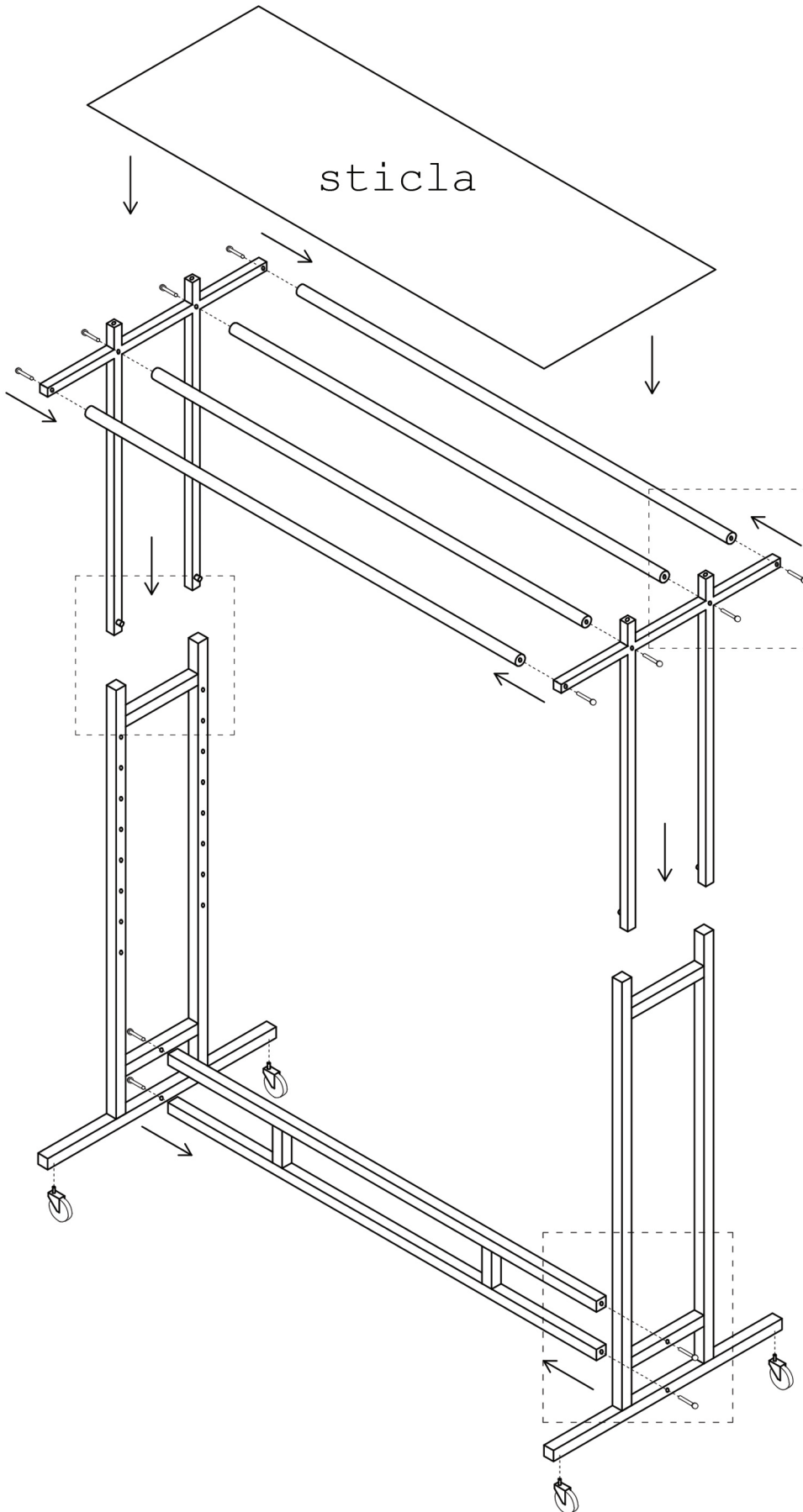

PASUL 3

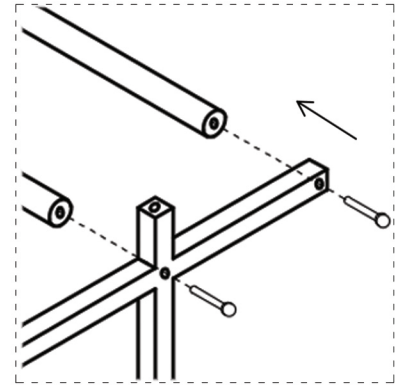

PASUL 2

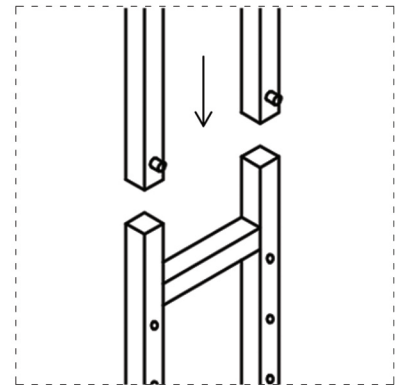

PASUL 1

