

MORE 01

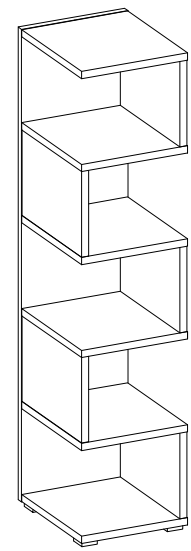

$\text{H}10 \times 50 \text{mm}$ O7	$\text{H}5.0 \times 70 \text{mm}$ P29	$\text{H}20$ E11						
1	1	1						
$\text{H}8 \times 30 \text{mm}$ A	$6.4 \times 50 \text{mm}$ B	$\text{H}5 / \text{H}8 \text{mm}$ C6	$L=20 \text{mm}$ D2	$\text{H}10 \times 30 \text{mm}$ E	$60 \times 40 \times 20$ F1	$\text{H}4.0 \times 25 \text{mm}$ P14	$\text{H}10 \times 30 \text{mm}$ O	
20	12	10	10	10	4	8	1	

ISM-RMO-001

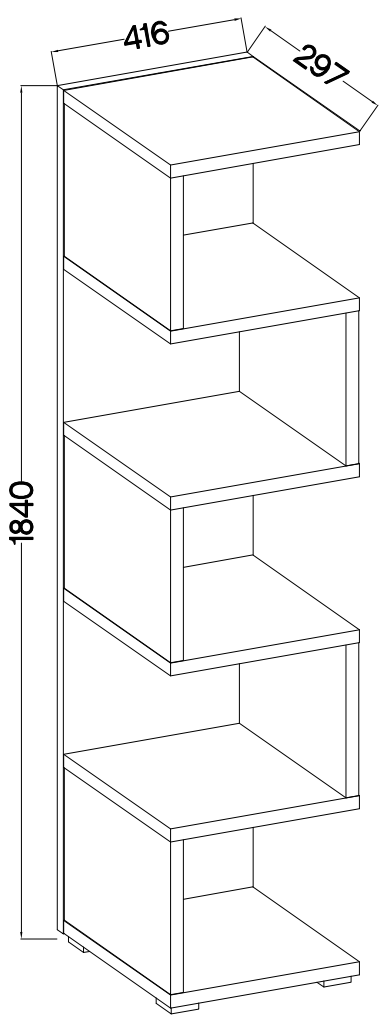
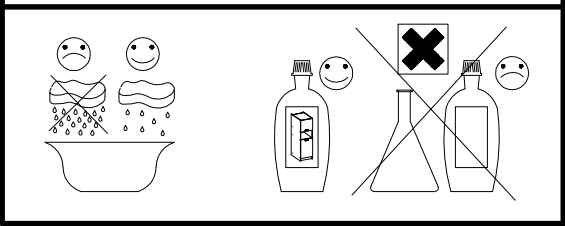
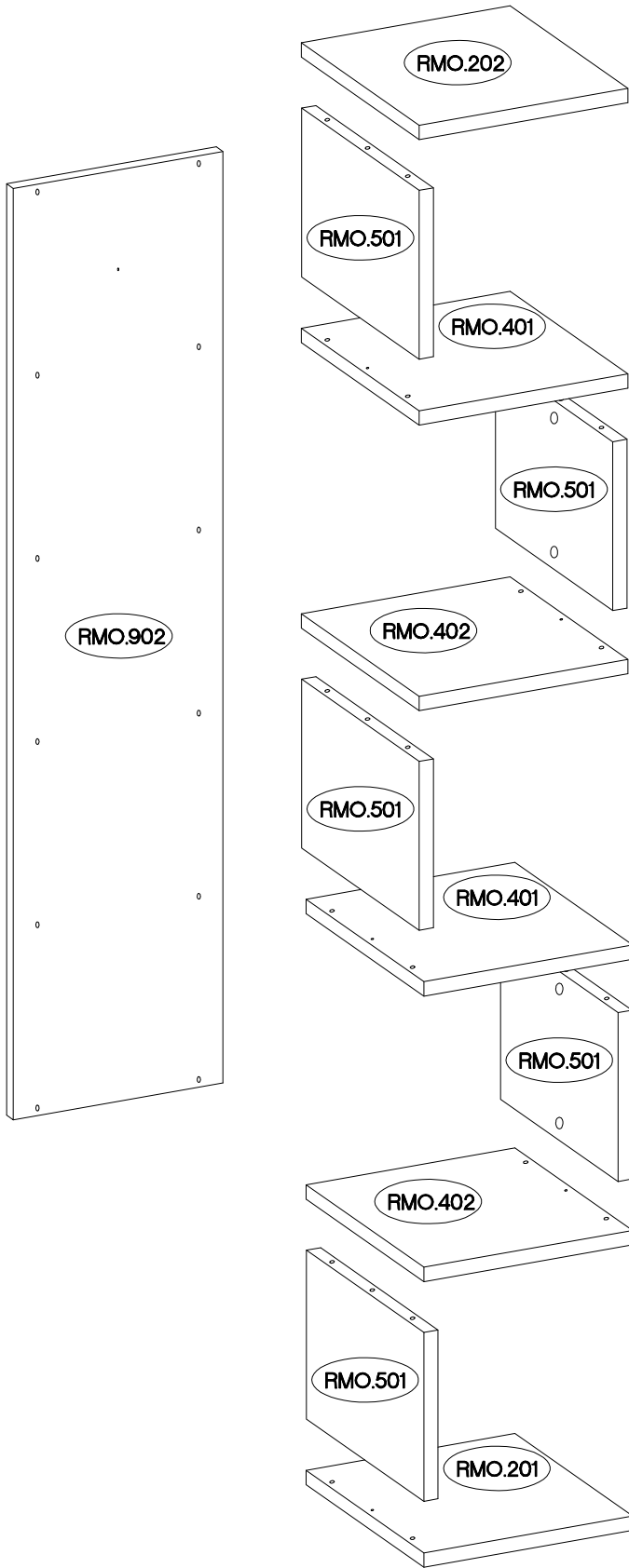

- RMO.201
- RMO.202
- RMO.401
- RMO.402

Colli	Ersatzteil Nummer	Dimension
Colli 1/1	RMO.201	414x281x28
	RMO.202	414x281x28
	RMO.401 x 2	414x281x28
	RMO.402 x 2	414x281x28
	RMO.501 x 5	330x280x28
	RMO.902	1820x416x16

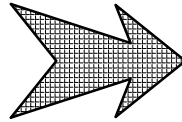
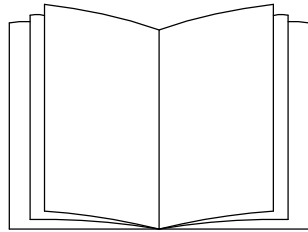
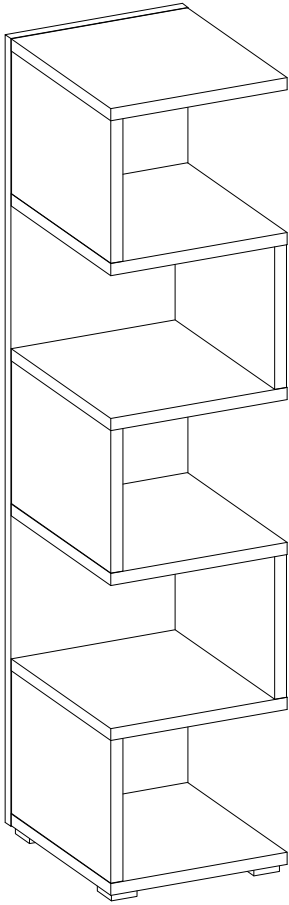

1 — 17

35

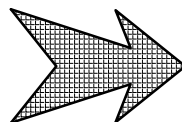
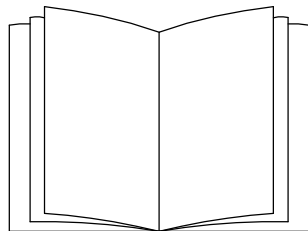
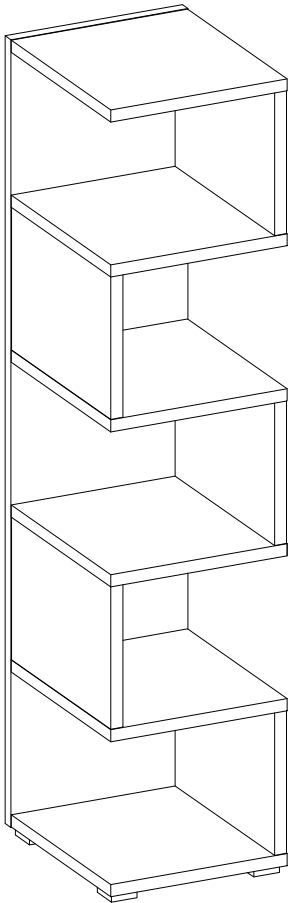



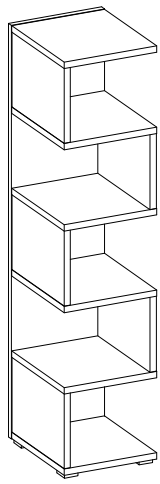

18 — 34

35

1

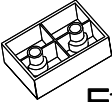

±8x30mm	±15/18mm	L=20mm	60x40x20	±4.0x25mm
				
A	C6	D2	F1	P14
20	10	10	4	8

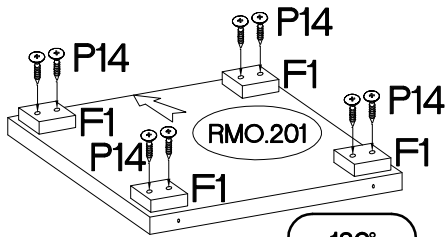
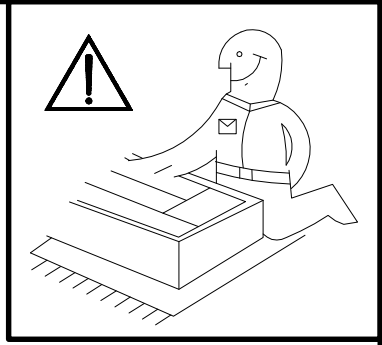

x1

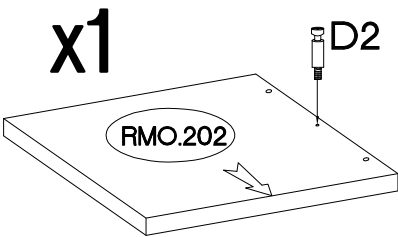
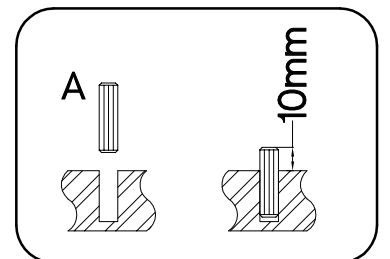
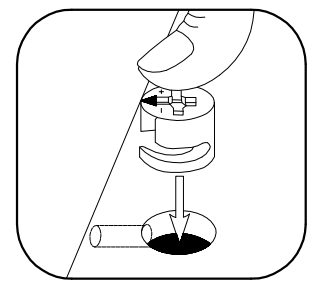
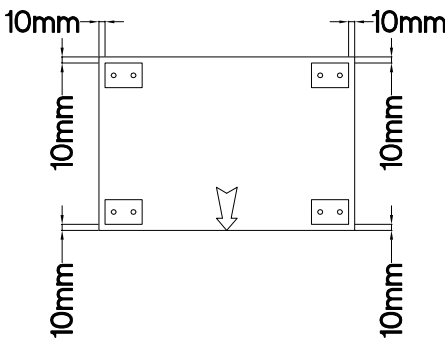
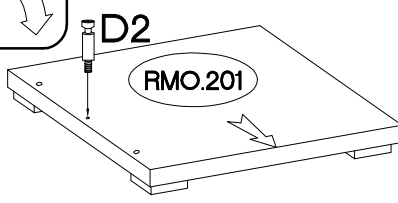
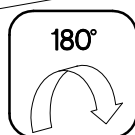

x1



x2

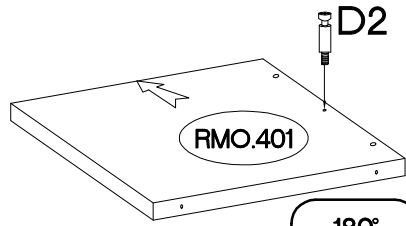
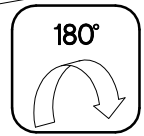

x2

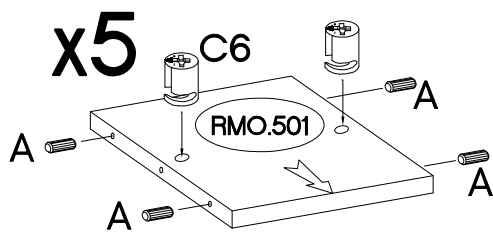
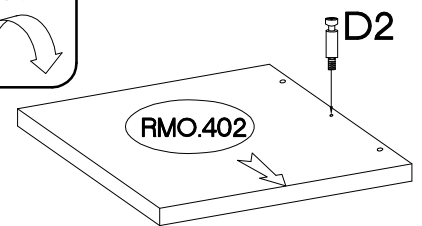
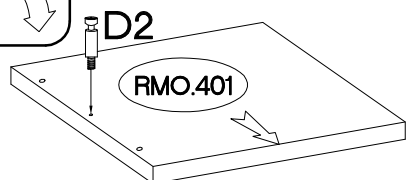
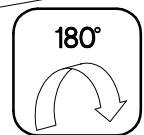

x5

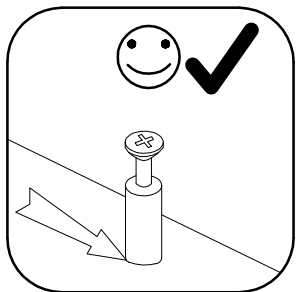
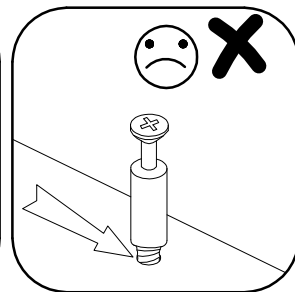
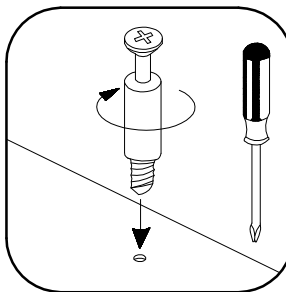

2

6,4 x 50mm

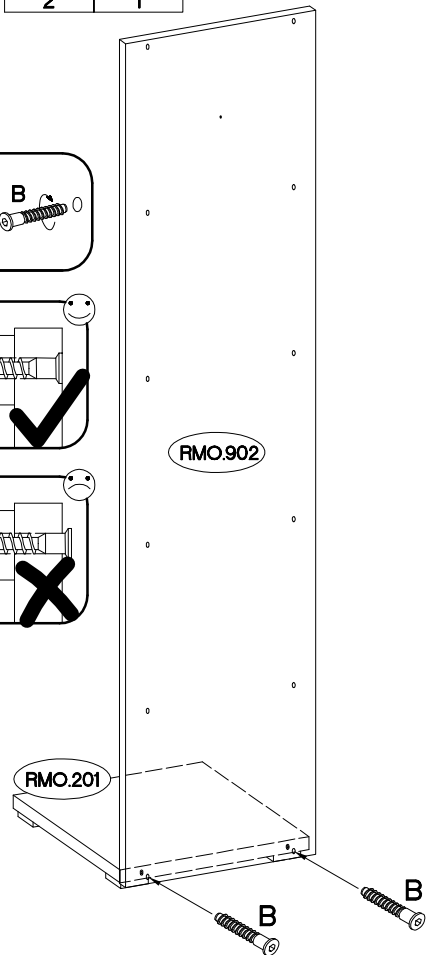
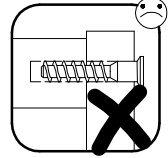
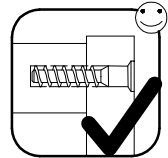
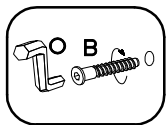
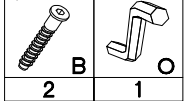

3

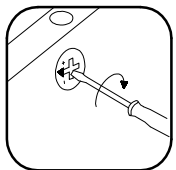
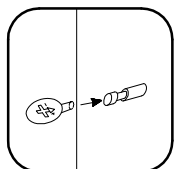
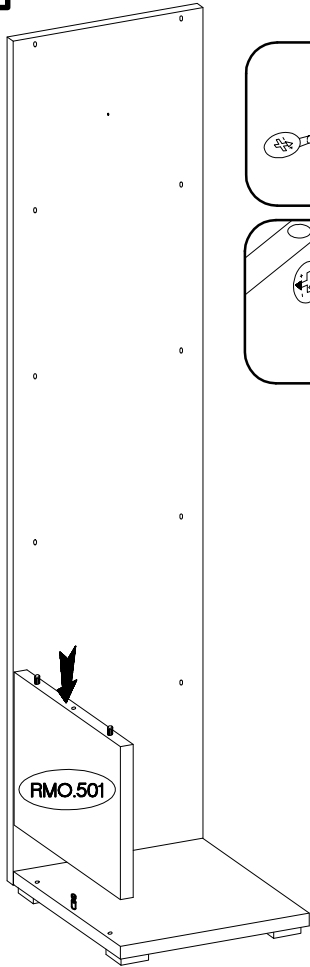

4

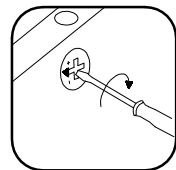
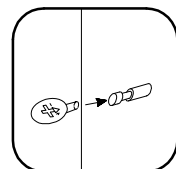
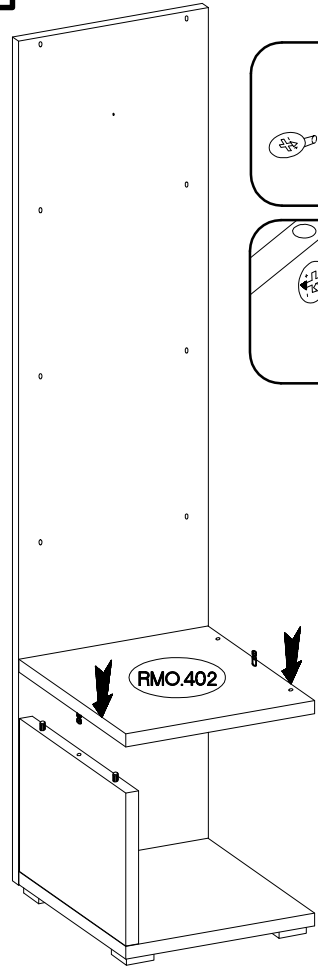

5

6,4 x 50mm

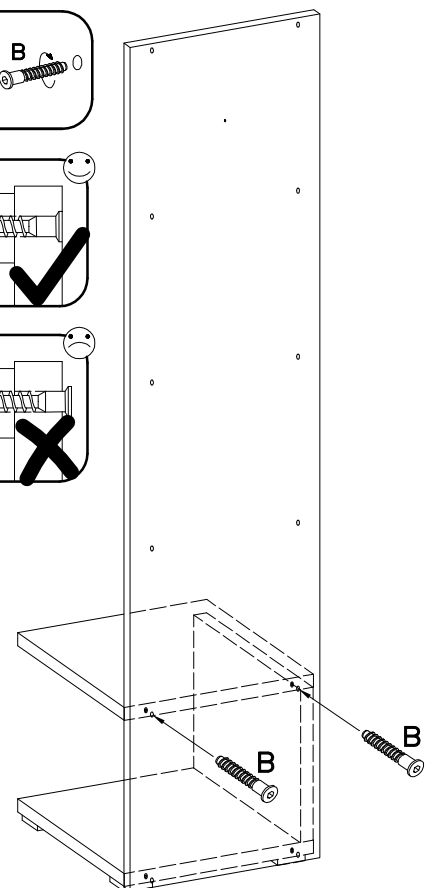
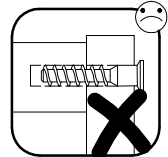
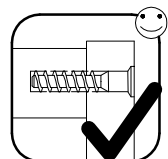
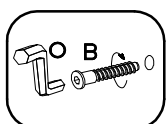
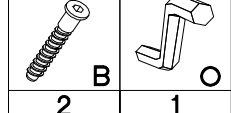

6

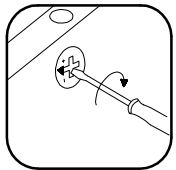
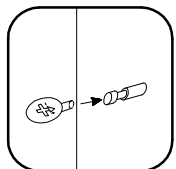
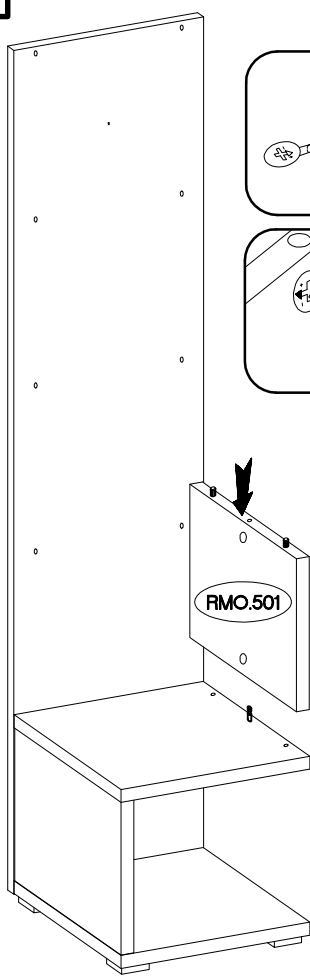

7

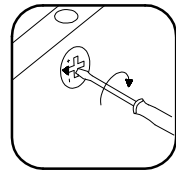
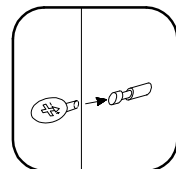
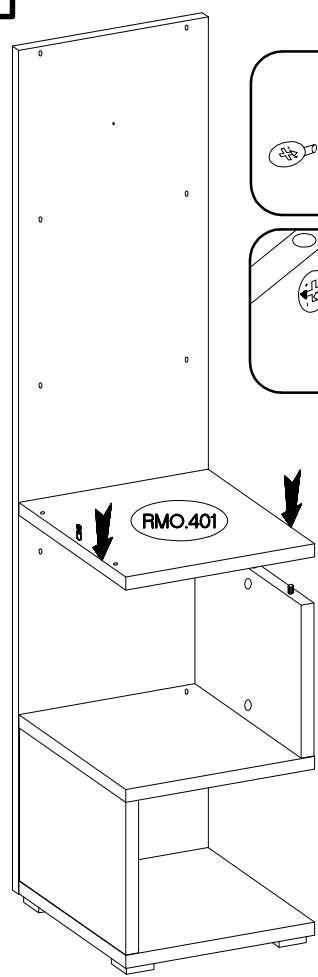

8

6,4 x 50mm



B



O

2

1

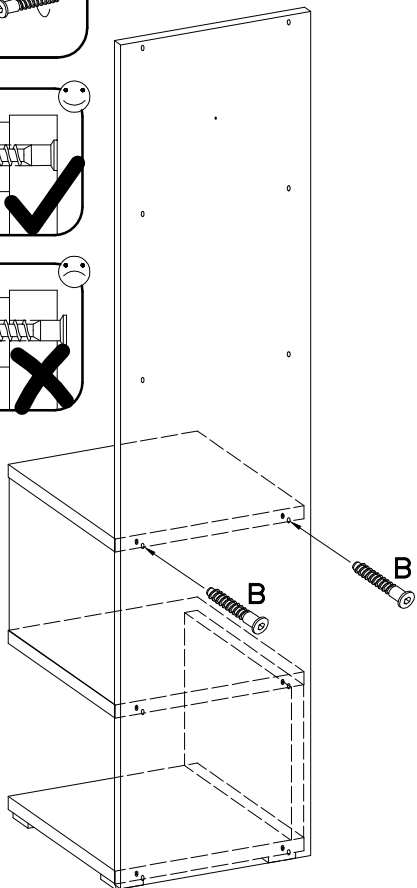
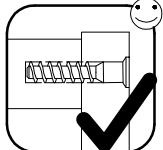
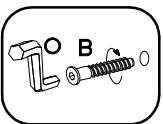

9

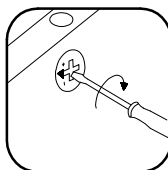
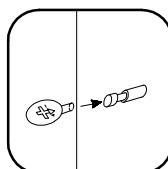
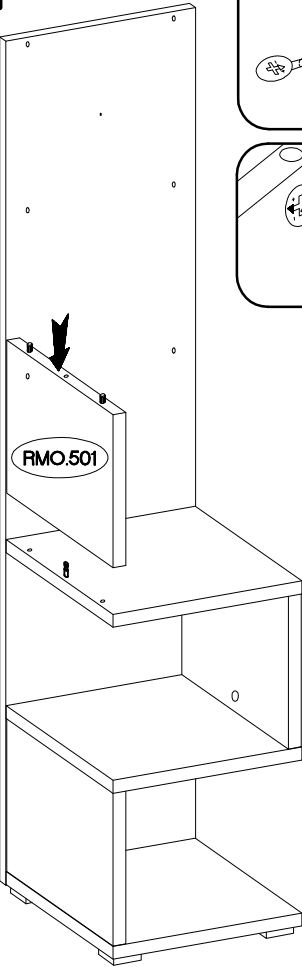

10

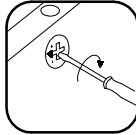
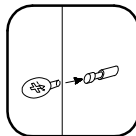
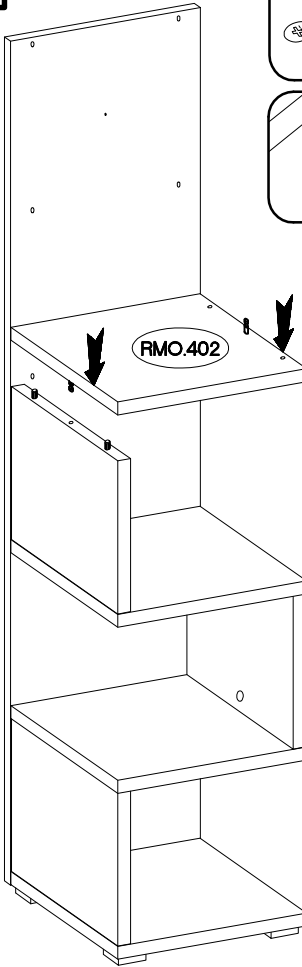

11

6,4 x 50mm



B



O

2

1

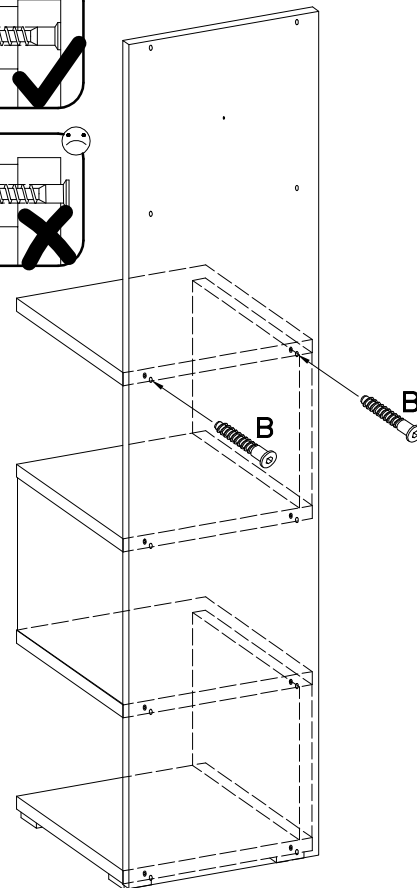
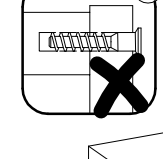
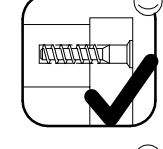
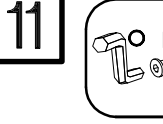

12

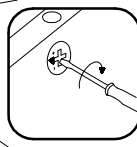
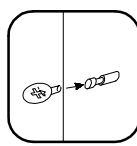
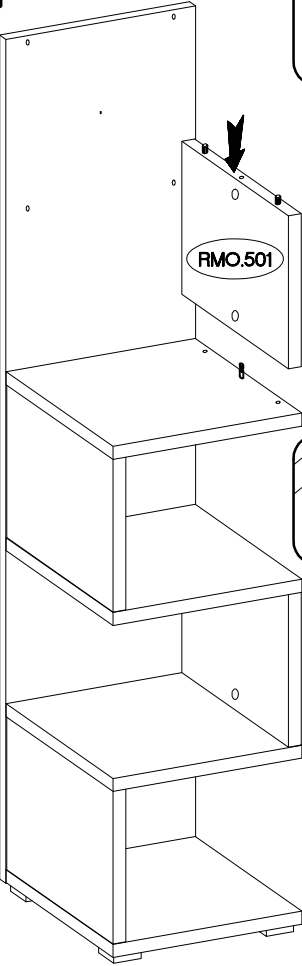

13

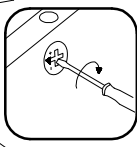
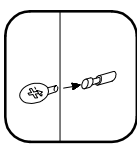
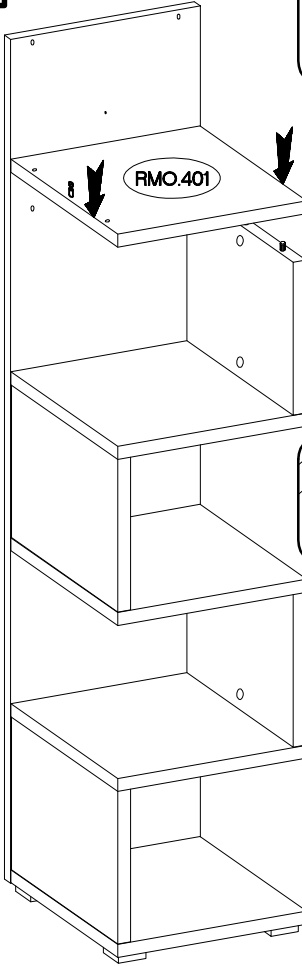

14

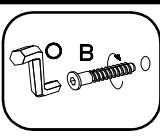

6,4 x 50mm



2



1

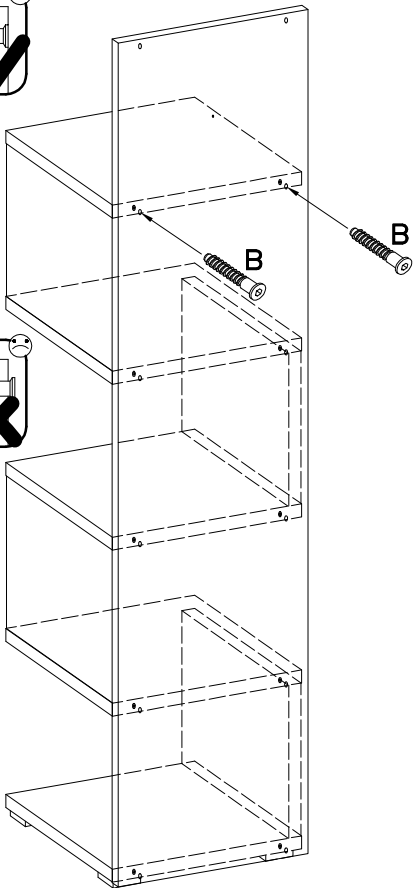

15

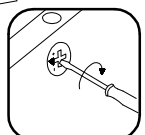
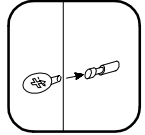
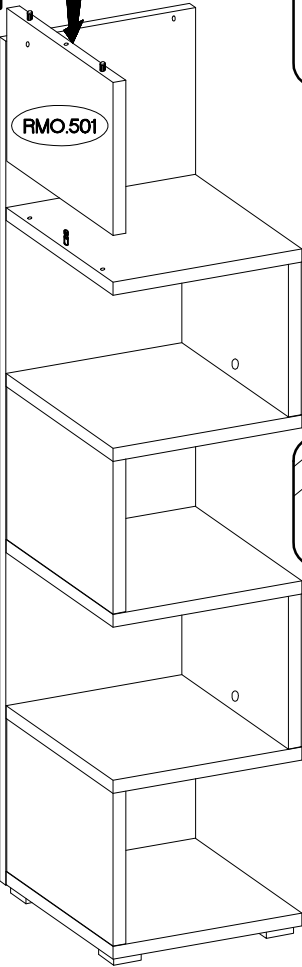

16

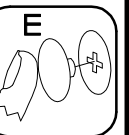
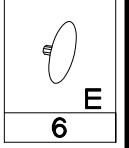
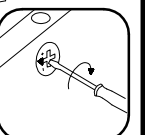
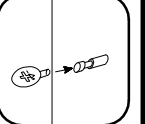
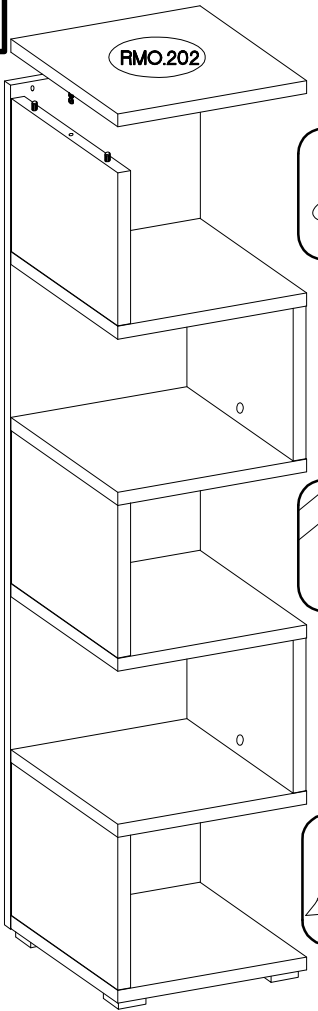

17

6,4 x 50mm







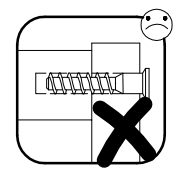
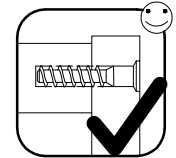
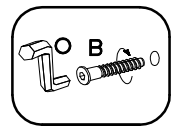
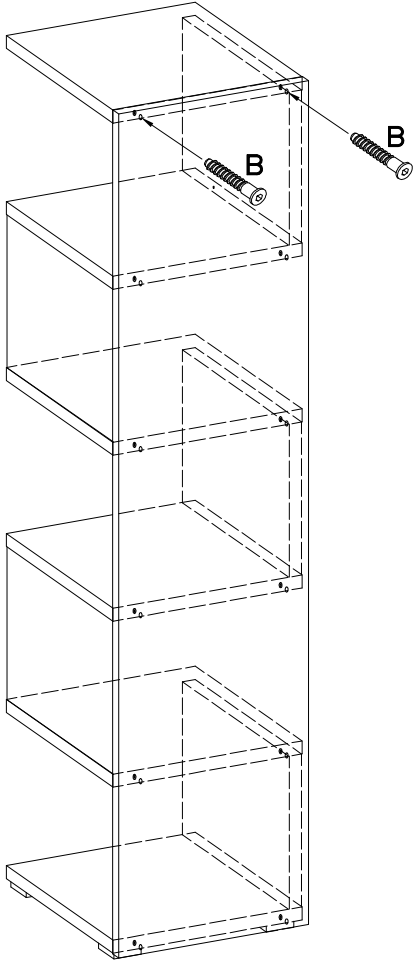

2

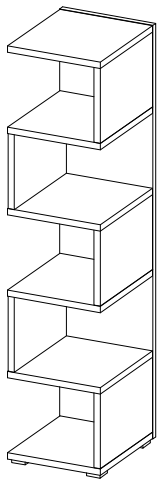

1



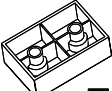

†8x30mm	†15/18mm	L=20mm	60x40x20	†4.0x25mm
				
A	C6	D2	F1	P14
20	10	10	4	8

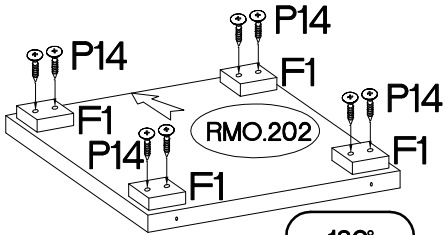
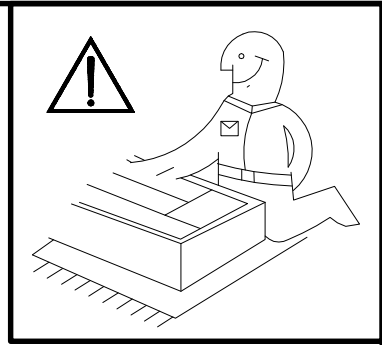

x1

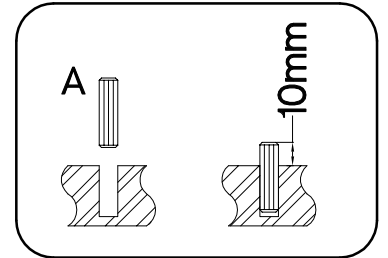
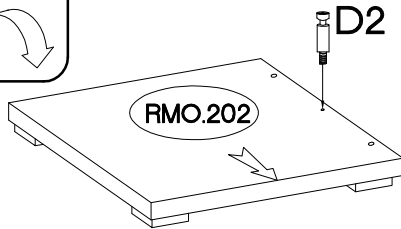
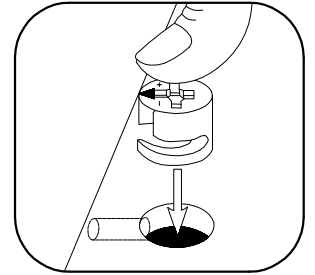
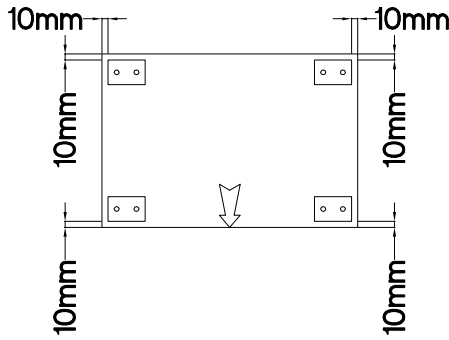
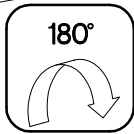

x1

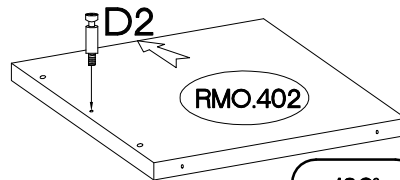
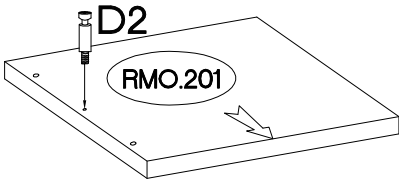

x2

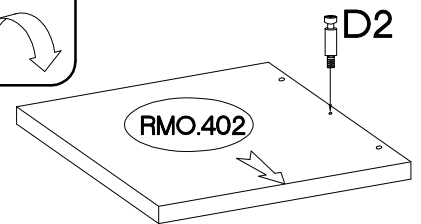
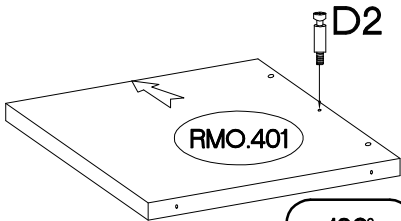
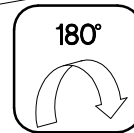

x2

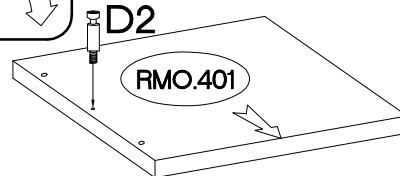
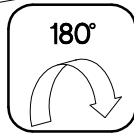

x5

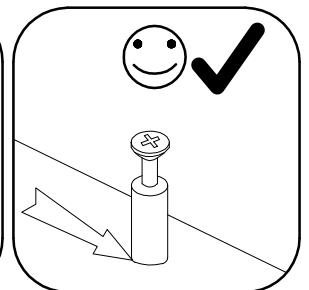
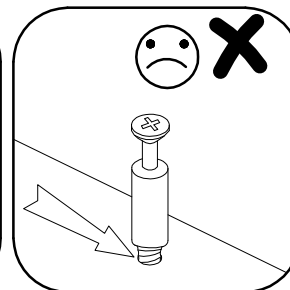
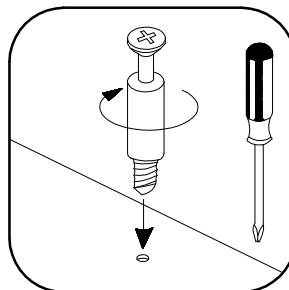
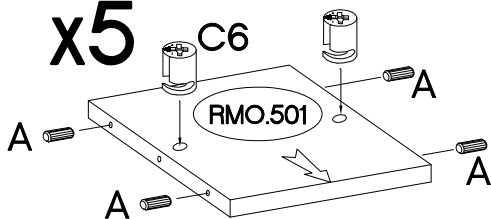

19

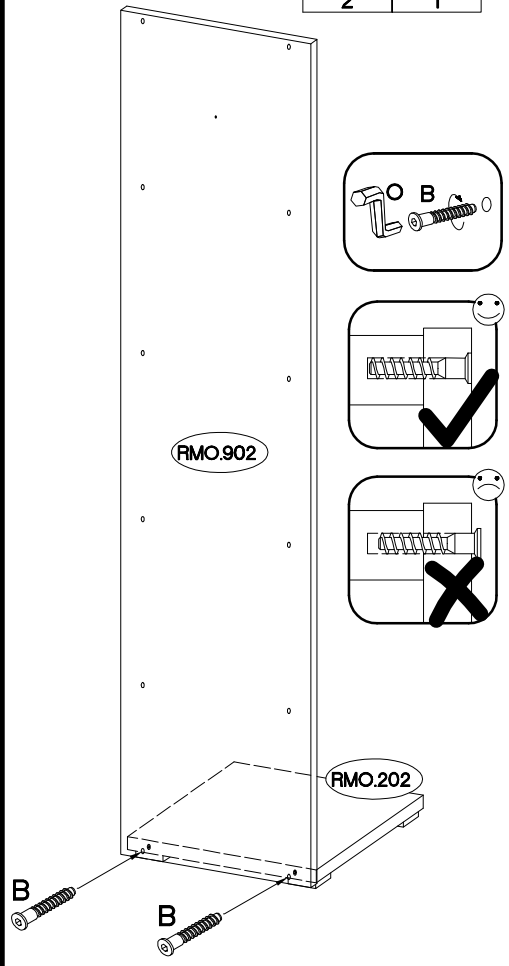
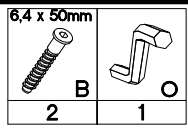

20

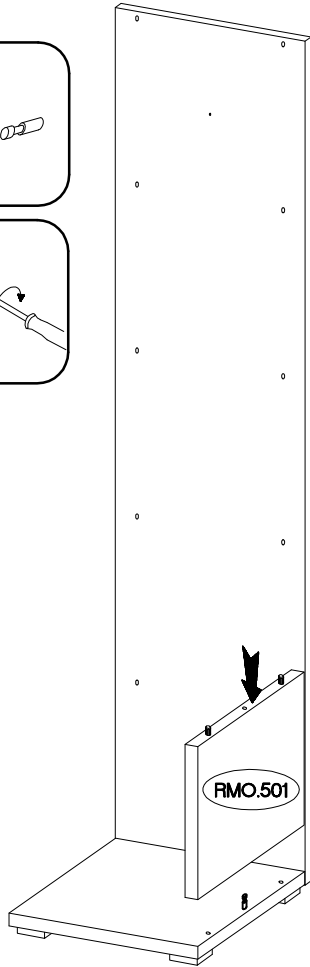
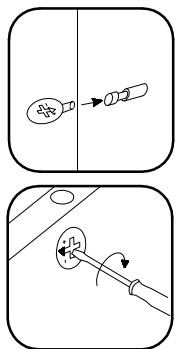

21

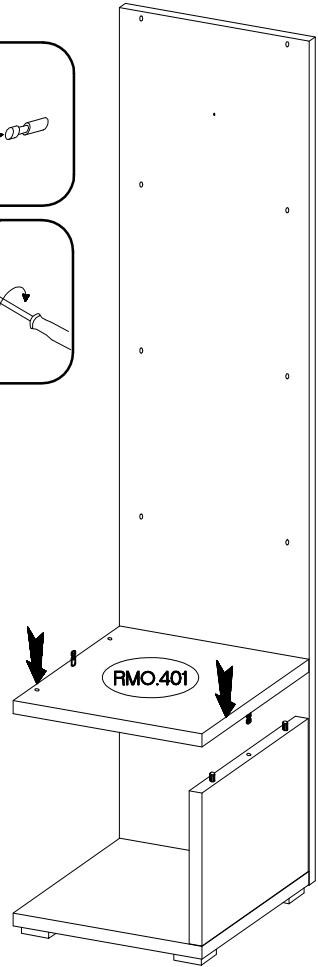
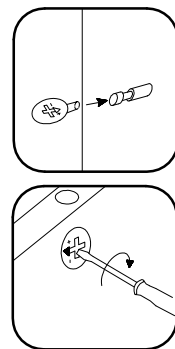

22

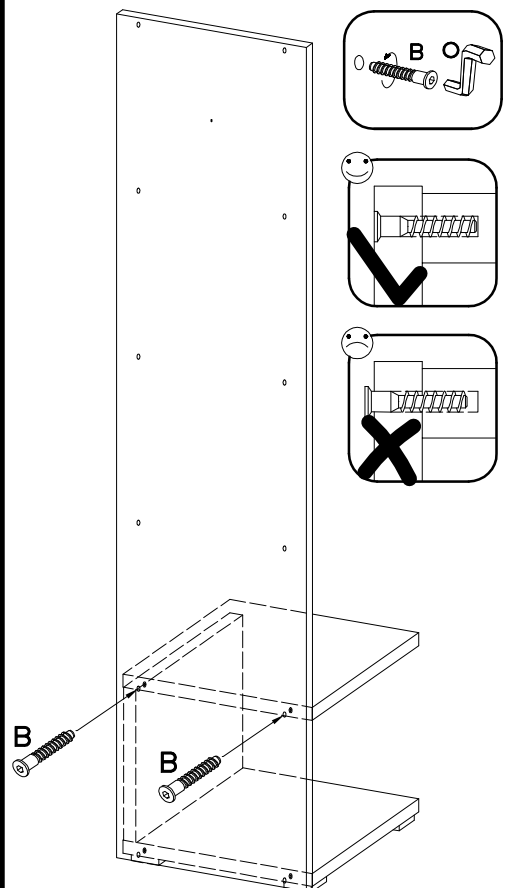
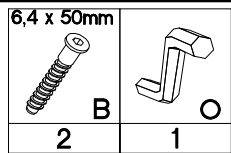

23

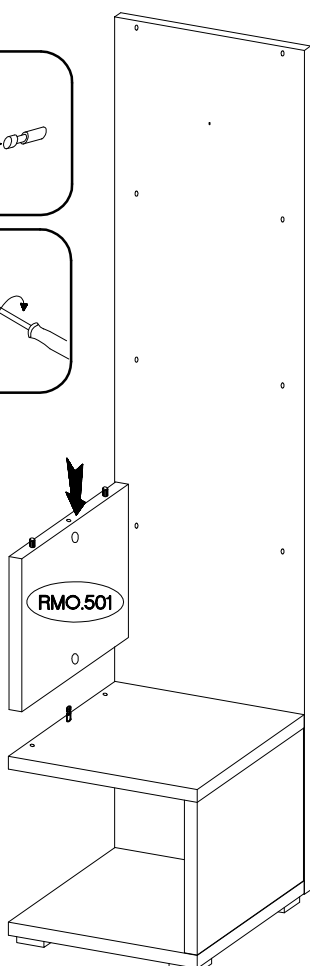
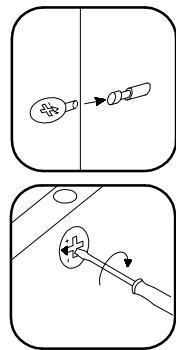

24

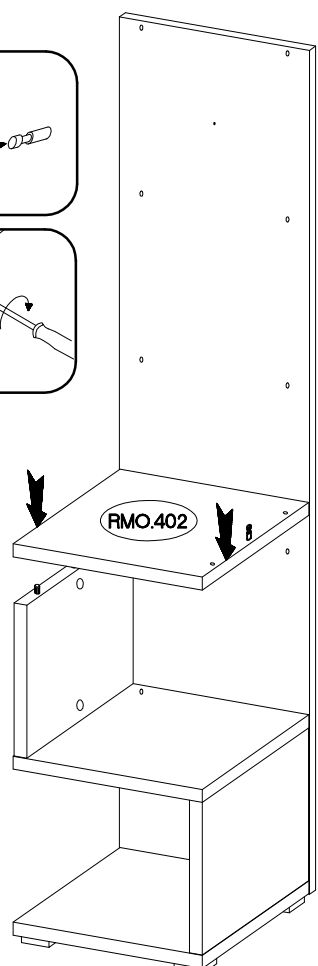
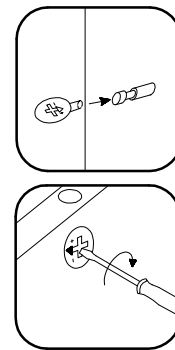

25

6,4 x 50mm



B



O

2

1

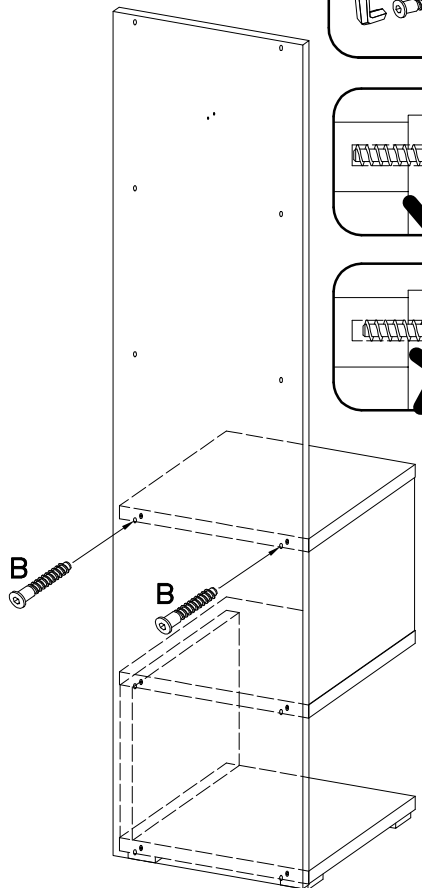
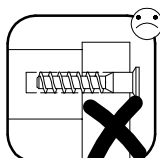
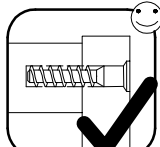
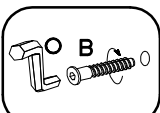

26

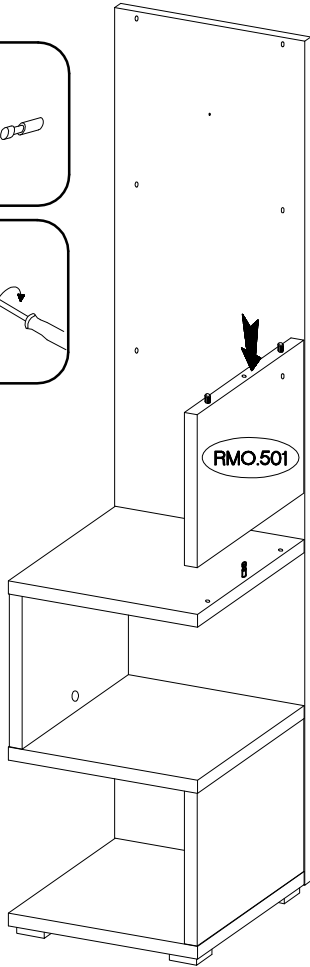
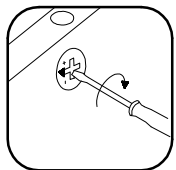
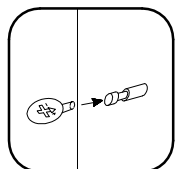

27

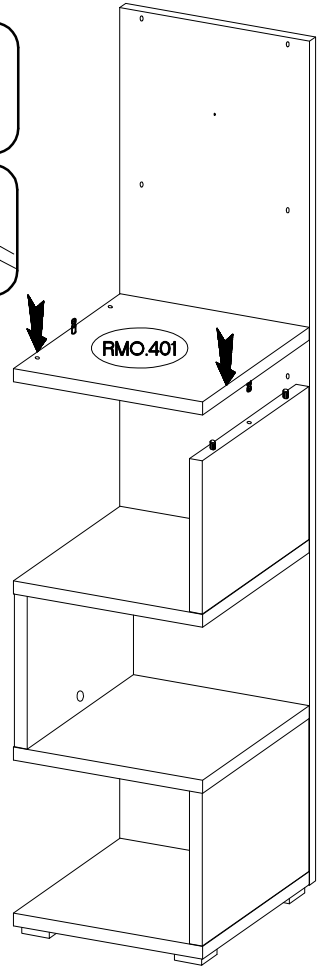
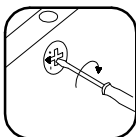
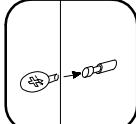

28

6,4 x 50mm



B



O

2

1

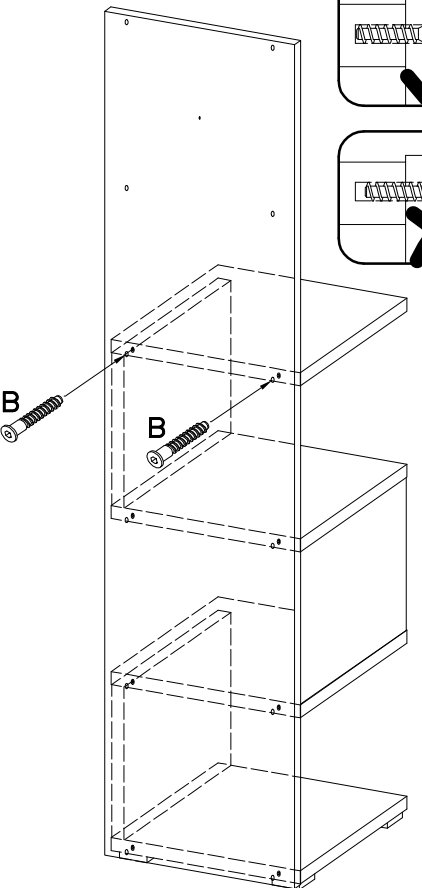
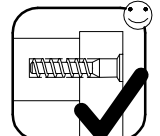
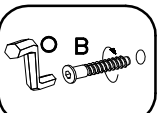

29

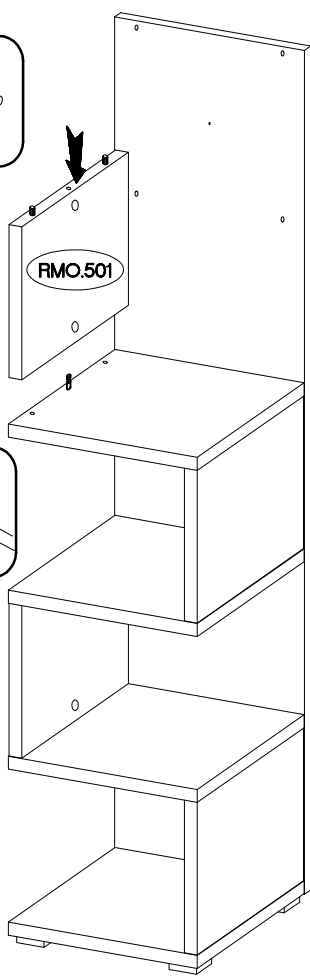
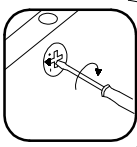
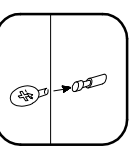

30

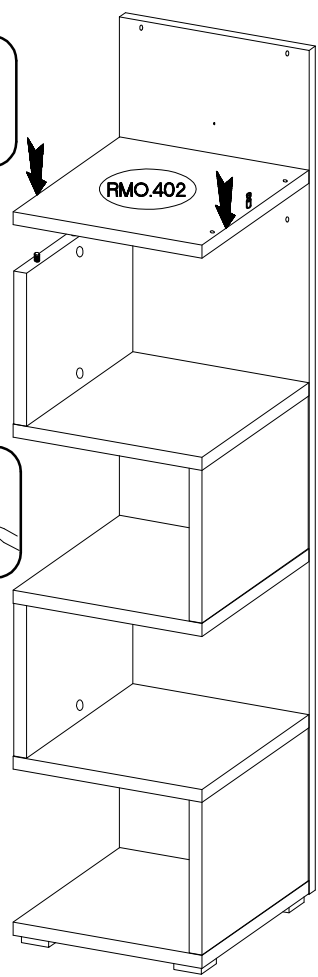
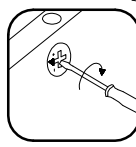
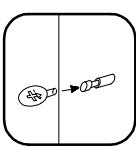

31

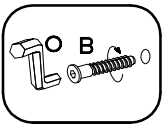

6,4 x 50mm

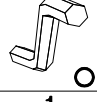

2

1

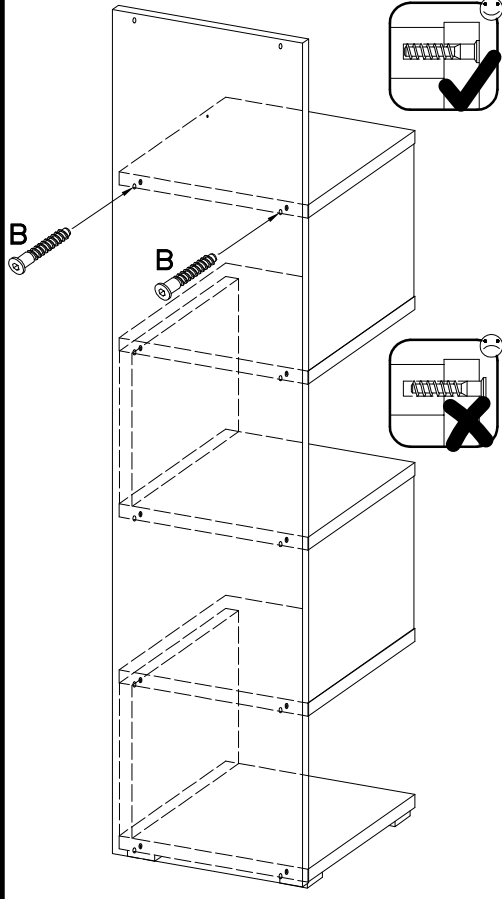

32

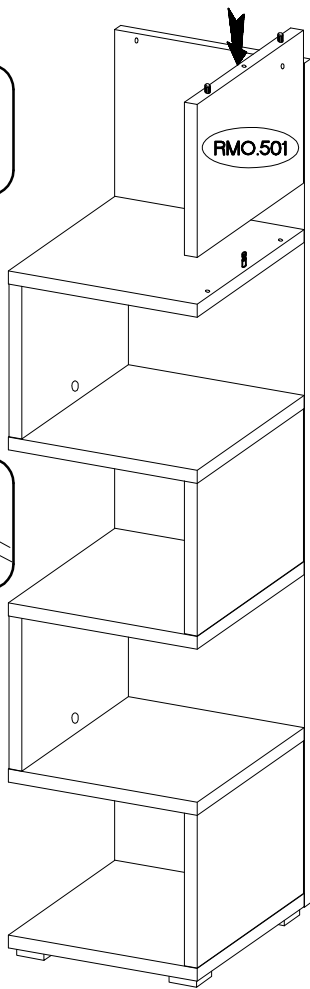
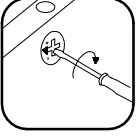
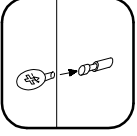

33

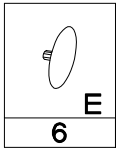
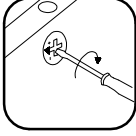
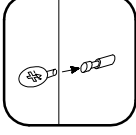

6

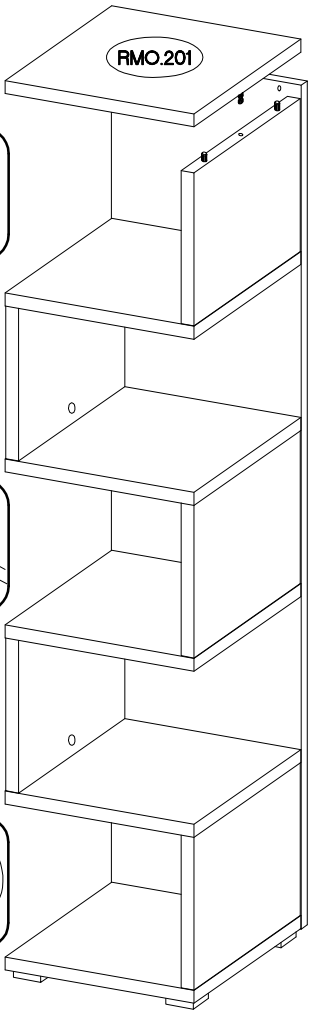
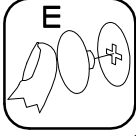



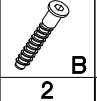

34

6,4 x 50mm

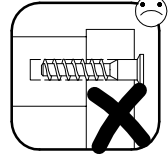
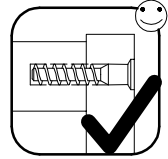
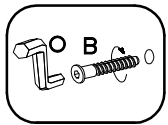
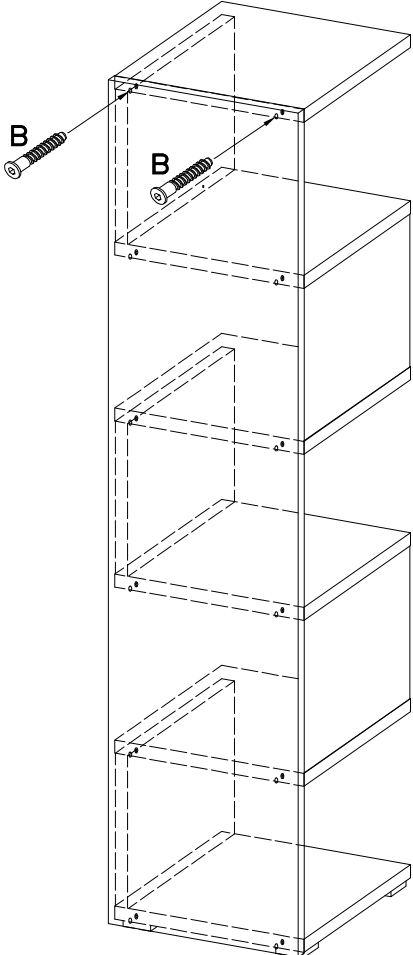
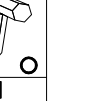

2



 #10x50mm O7 1	 #5.0x70mm P29 1	 #20 E11 1
--	--	--

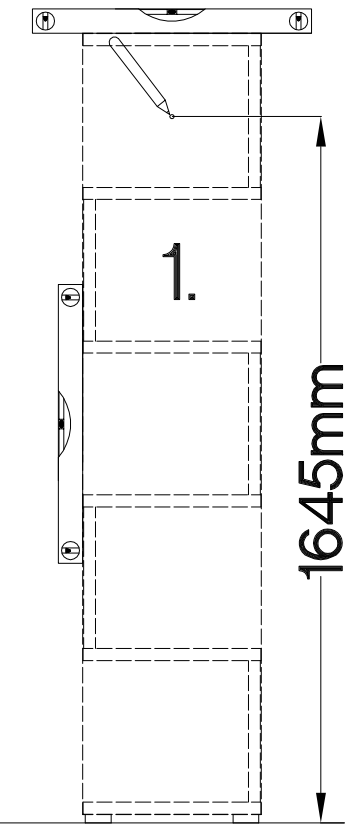
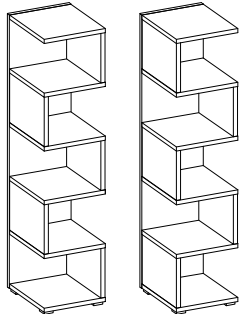

Ø10mm

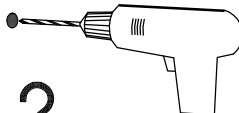

2.

O7

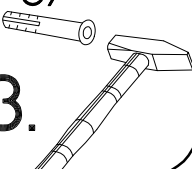

3.

