

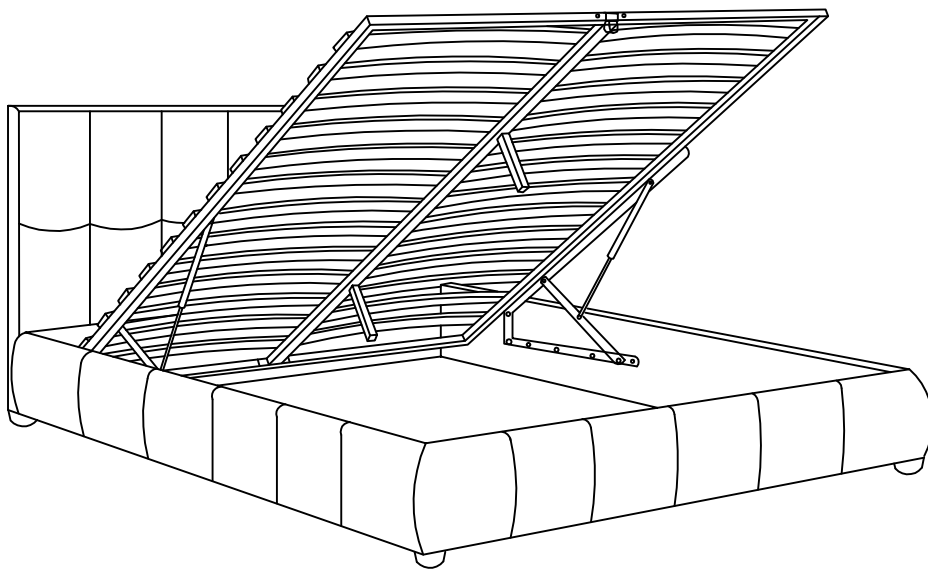

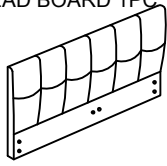

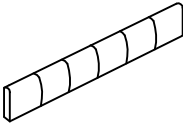

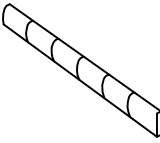

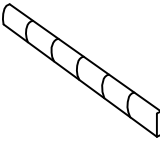



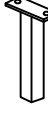
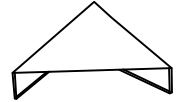
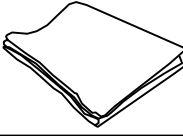
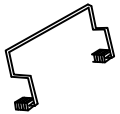

ASSEMBLY INSTRUCTIONS

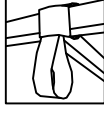

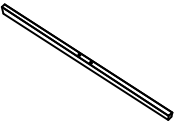

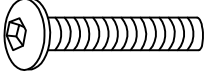
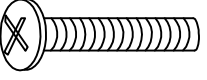
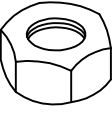

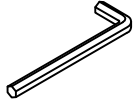
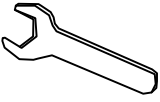
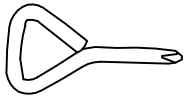
Parts List

A HEAD BOARD 1PC 	B FOOT BOARD 1PC 	C SIDE RALL1PC 	D SIDE RALL 1PC 
E BEDSTEAD RAIL 2 SETS 	F SLAT 30 PCS 	G Single Plastic Cap 30pcs 	H Double Plastic Cap 15pcs 
I LEG 4 PCS 	J 4 PCS 	K Support Leg 2 PCS 	L 2 pcs 
M Non-woven fabrics 1pc 	N 1 PCS 	O Center Support Bar 1pc 	P Digging rope 1PC 
Q 2 PCS 	R BEDSTEAD RAIL 2 SETS 		

Hardware List



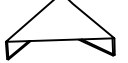

1 M8*30 x20 PCS 	2 M8*40 x 14 PCS 	3 14 pcs 	4 4 pcs 
5 4pcs 	6 M5 x1 PC 	7 1 pcs 	8 1 pcs 
9 M4*40 x4 PCS 			

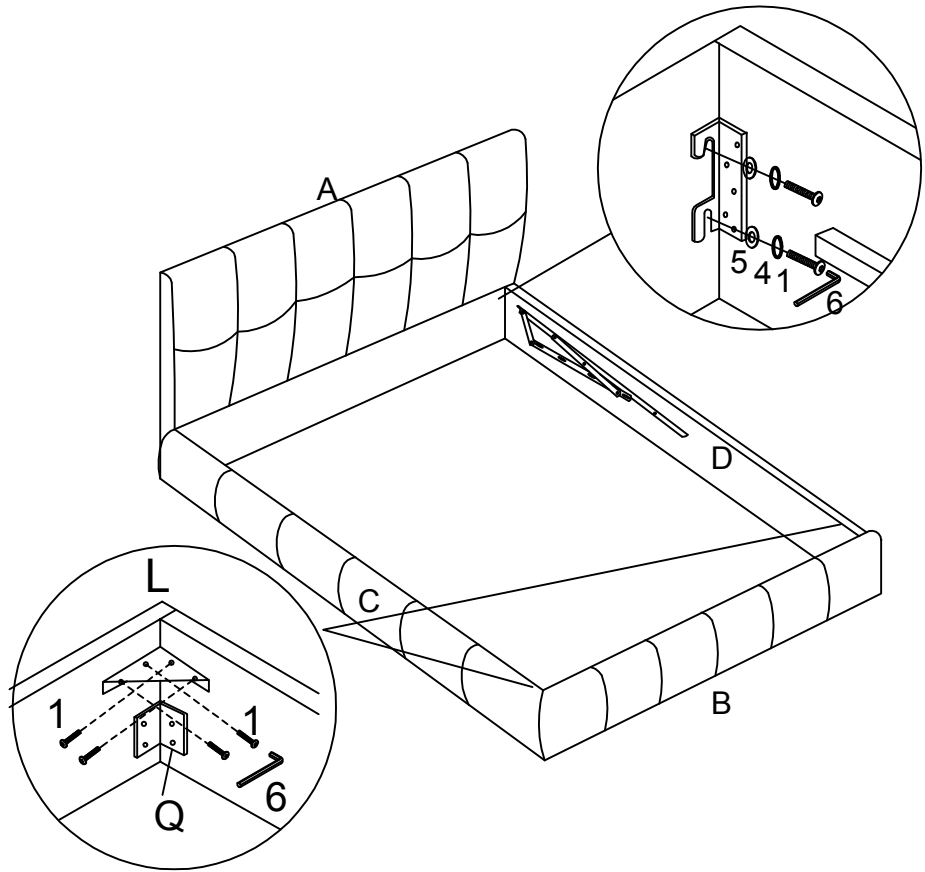
Step1

- 5  4pcs
- 4  4pcs
- 1  20pcs
- 6  1pc
- L  2pcs



Step2

- J  4 pcs
- 2  4 pcs
- 3  4 pcs
- 7  1 pc
- 8  1 pc

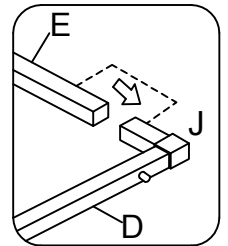
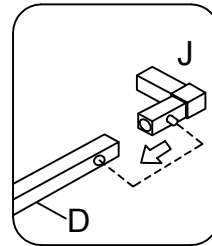
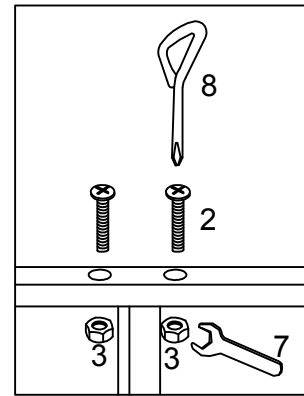
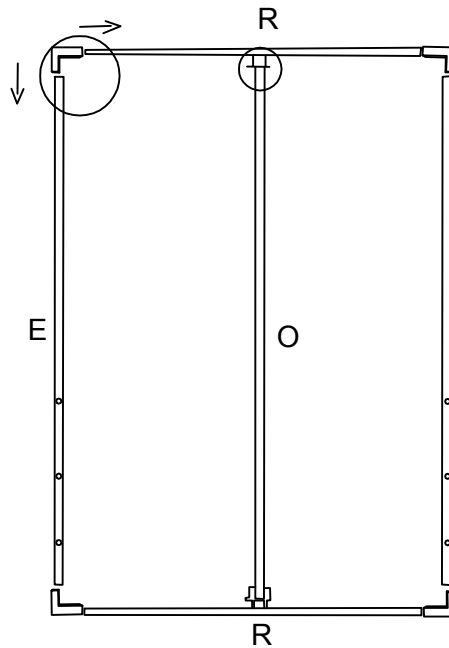

Step3

8  1 pc

6  1 pc

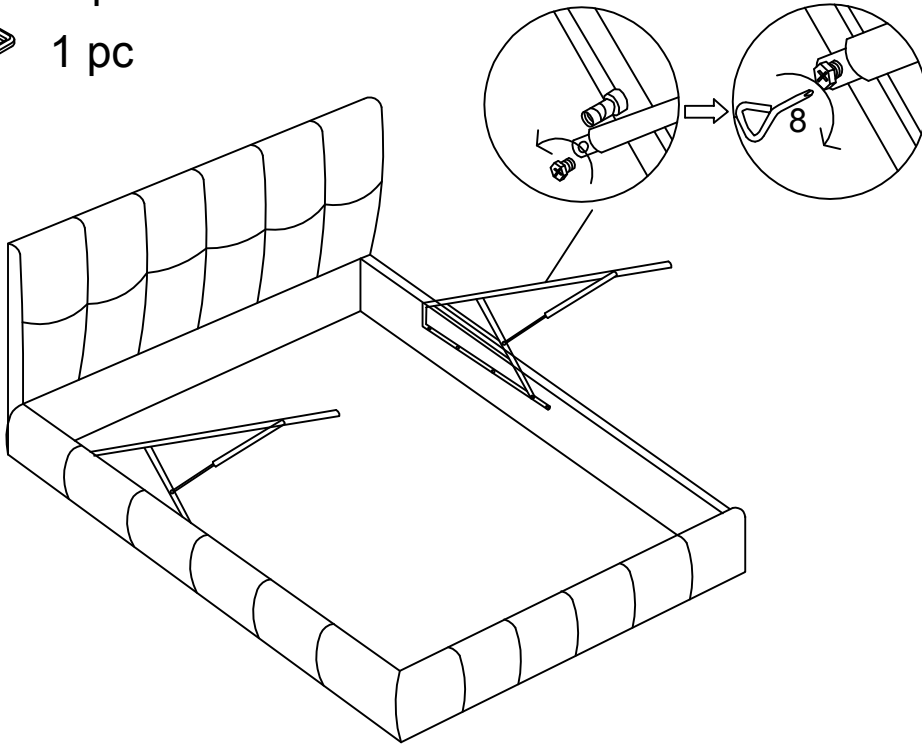

Step4

2  10 pcs

3  4 pcs

7  1 pc

8  1 pc

K  2 pcs

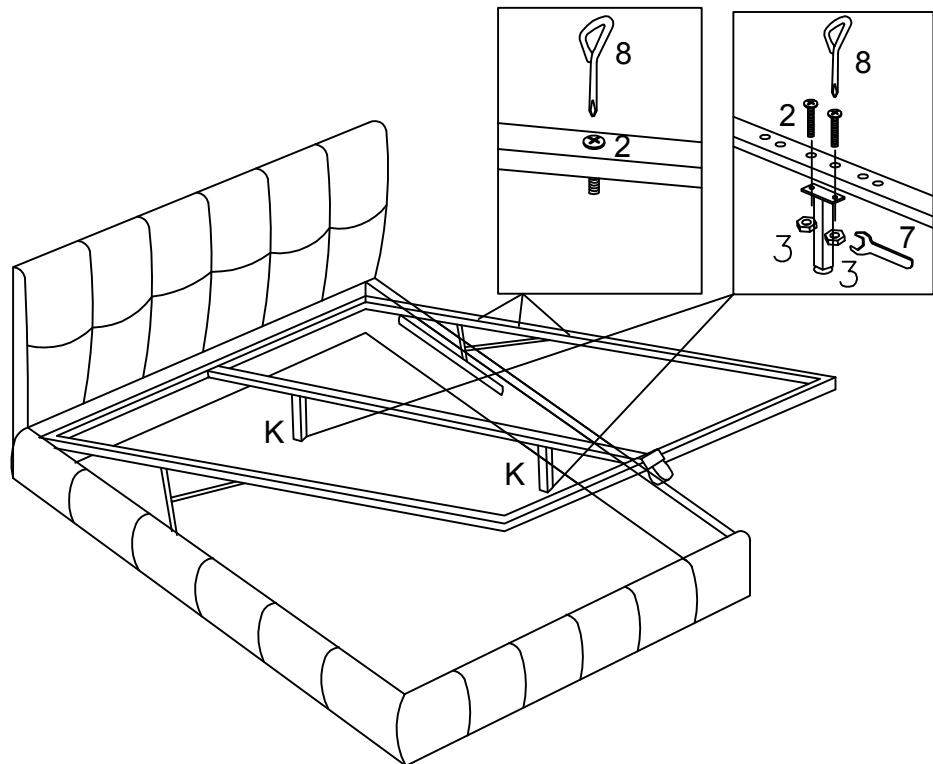

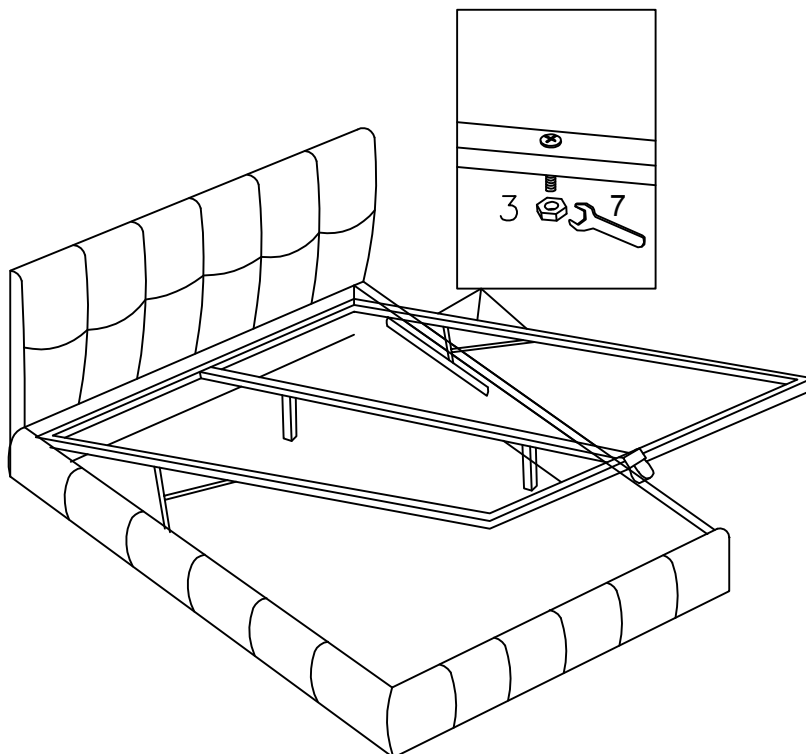

Step5

- 3  6 pcs
7  1 pc



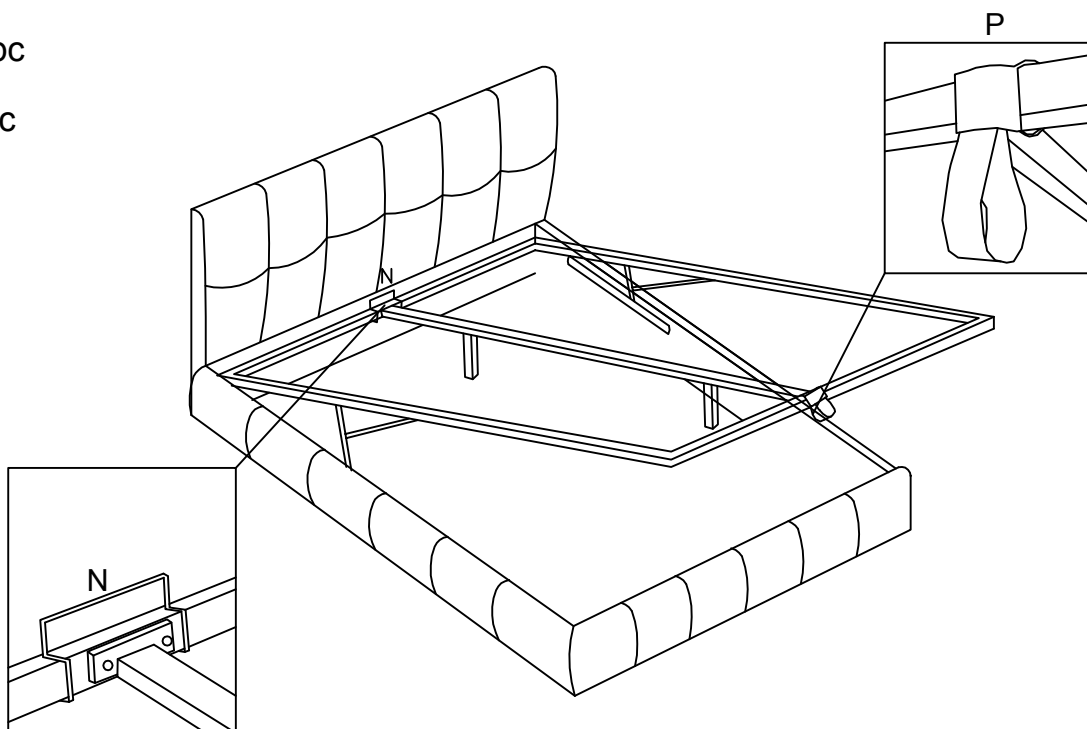

Step6

- P  1 pc
N  1pc





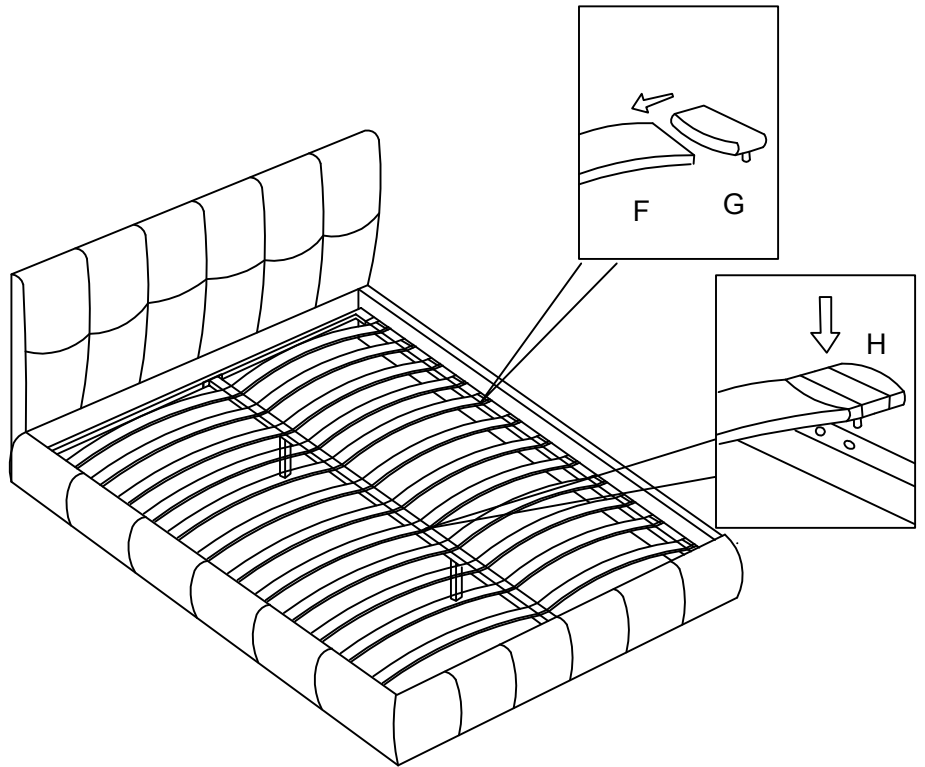

Step7

- F  30 pcs
- G  30 pcs
- H  15 pcs



Step8

- M  1 pc
- I  4 pcs
- 8  1 pc
- 9  4 pcs

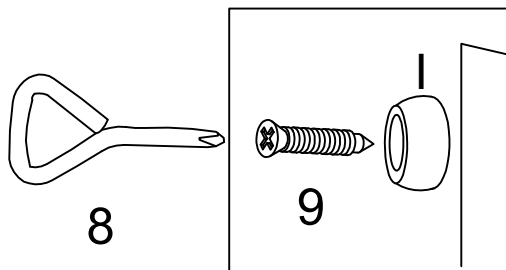
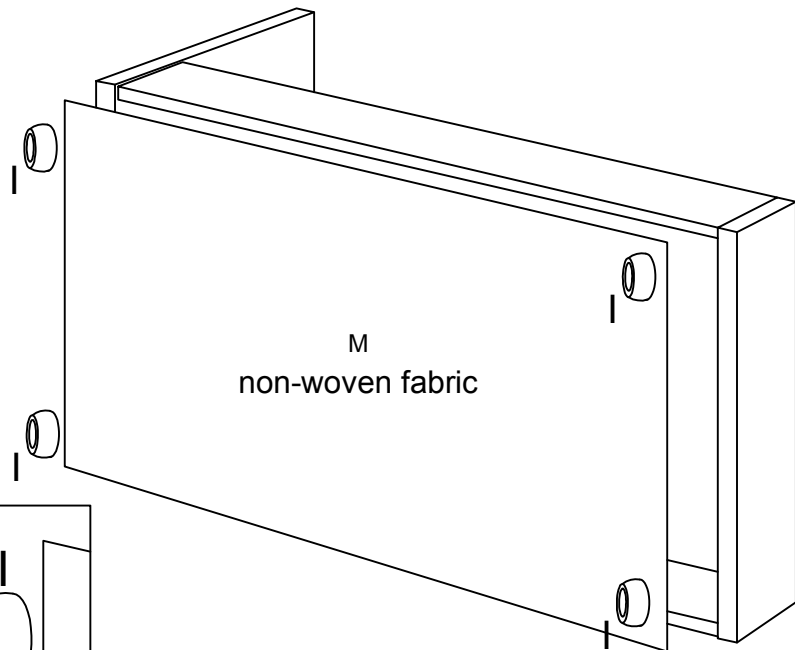

X4

Stick the non-woven fabric on bottom and then assemble the 4 foot