

ALDEIA

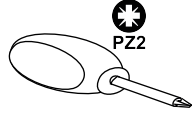

30min

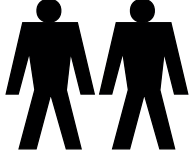

PZ2

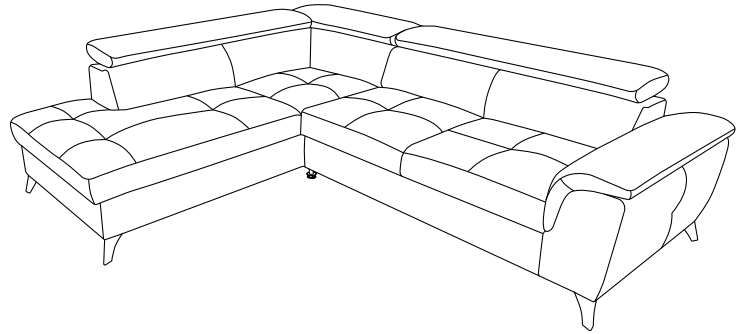
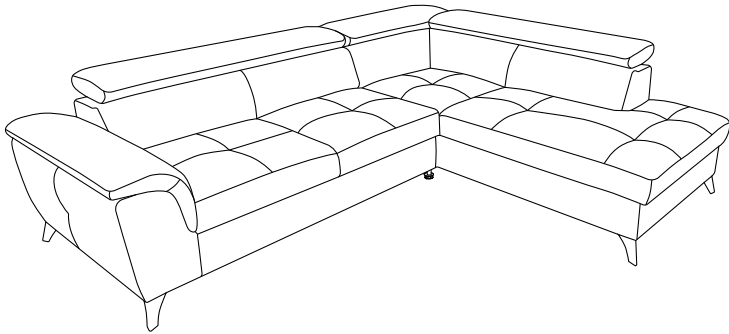
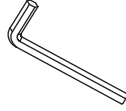

I

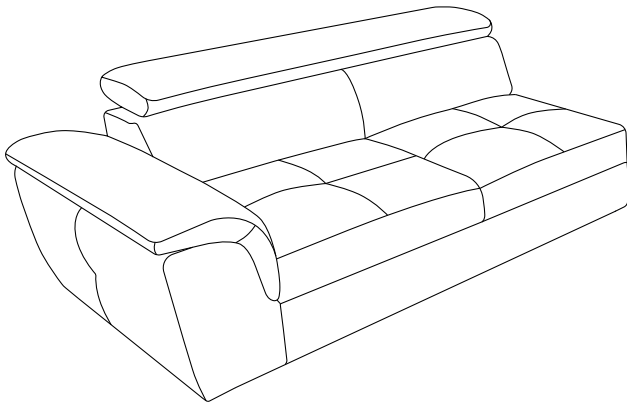

II

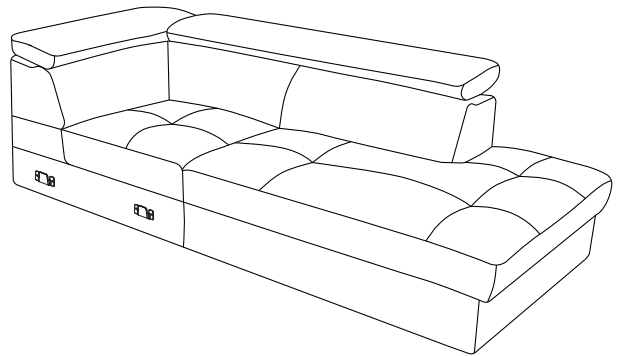

Ax4



H=105 mm

Bx3



H=100 mm

Cx1

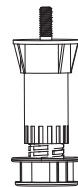

H=90-140 mm

Dx12

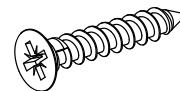

5x25

Ex4

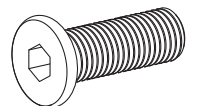

8x25



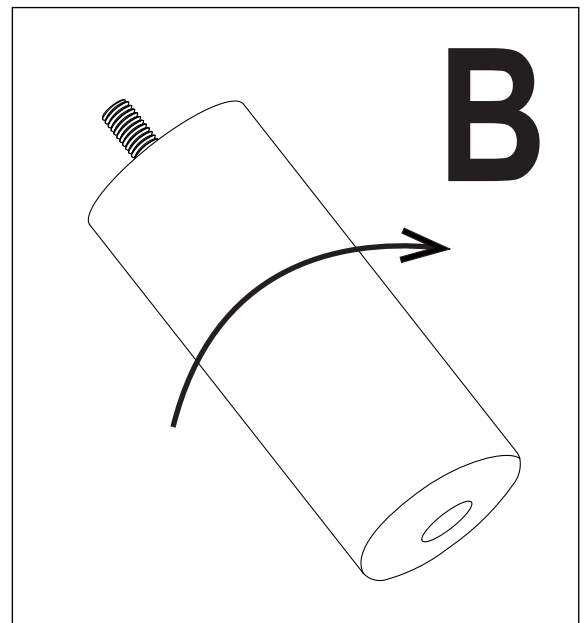
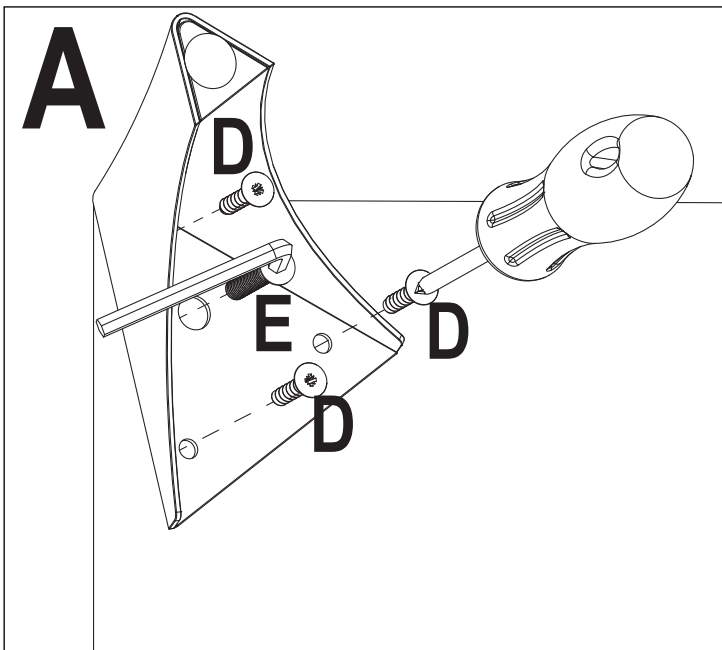
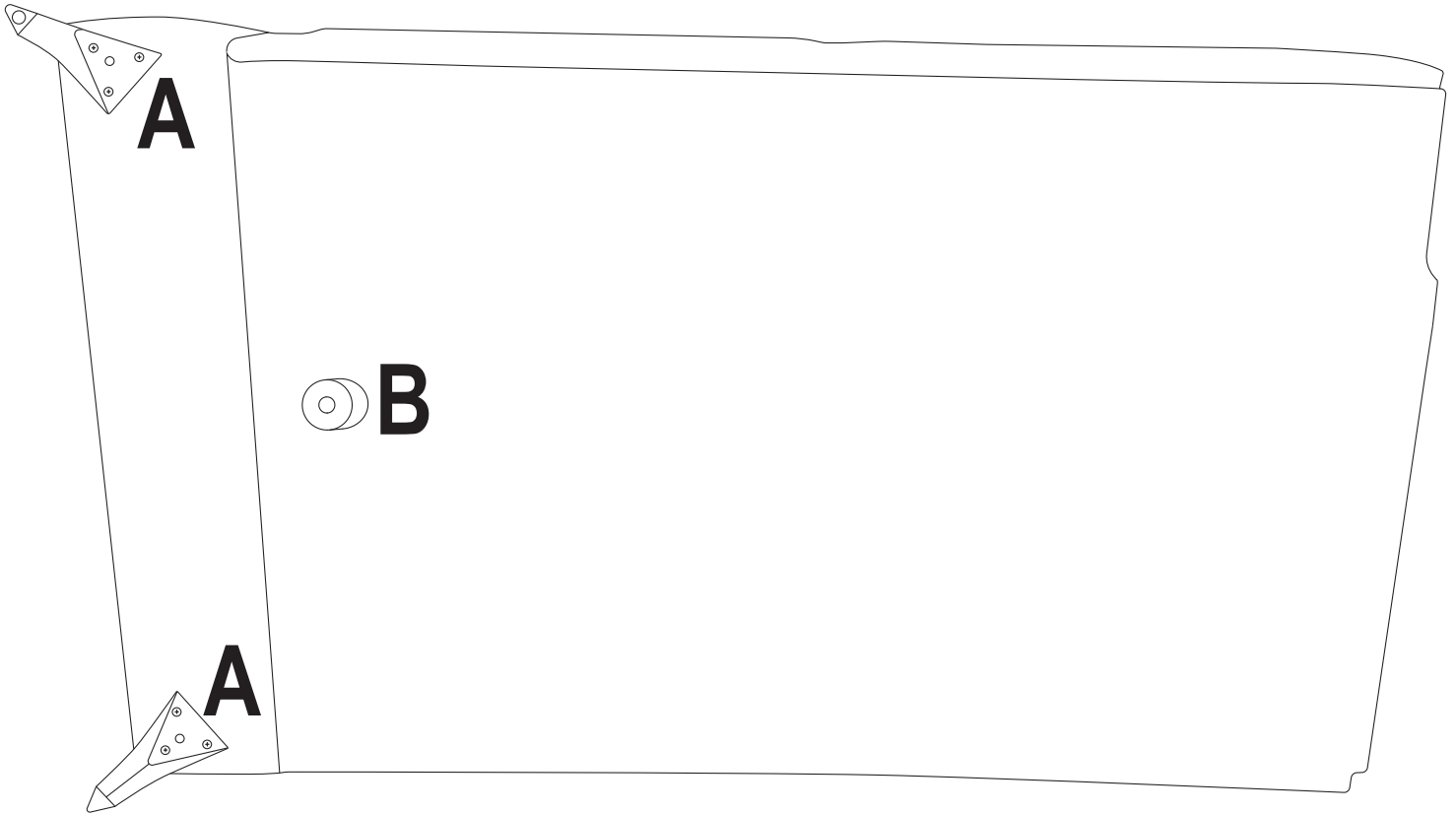
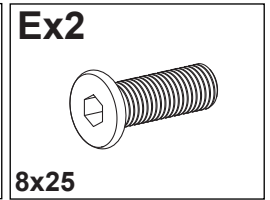
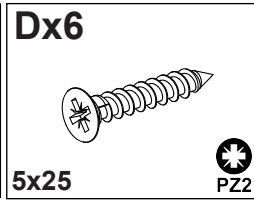
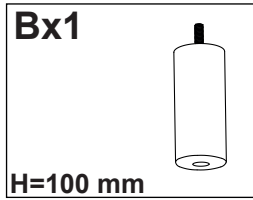
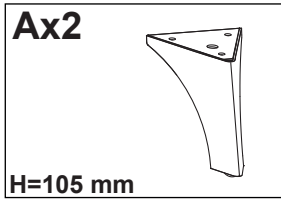

PZ2

1



2

Ax2

H=105 mm

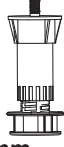
Bx2

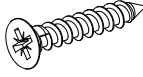
H=100 mm

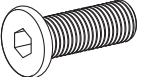
Cx1

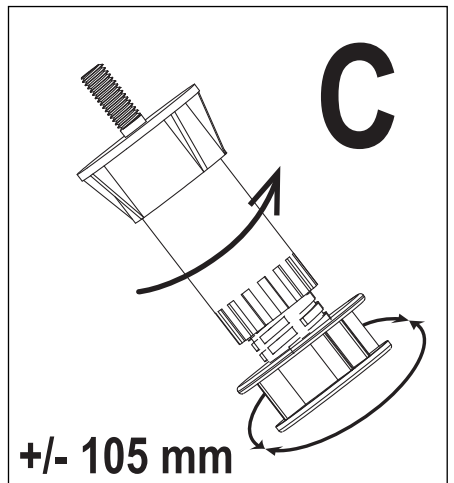
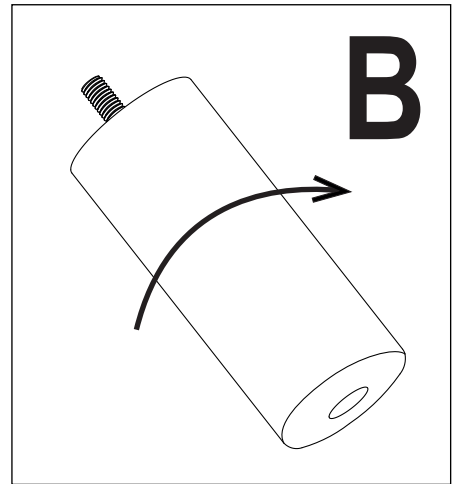
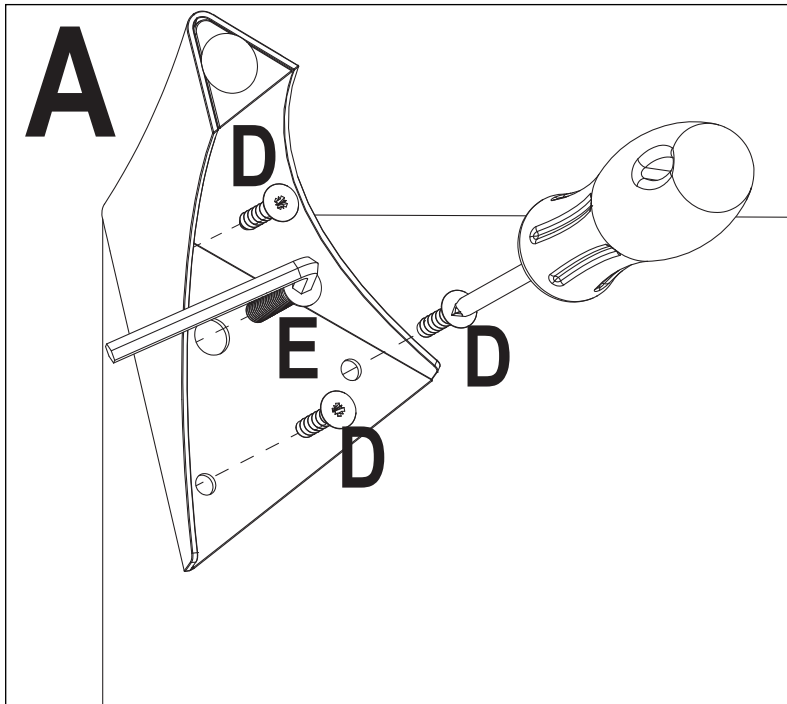
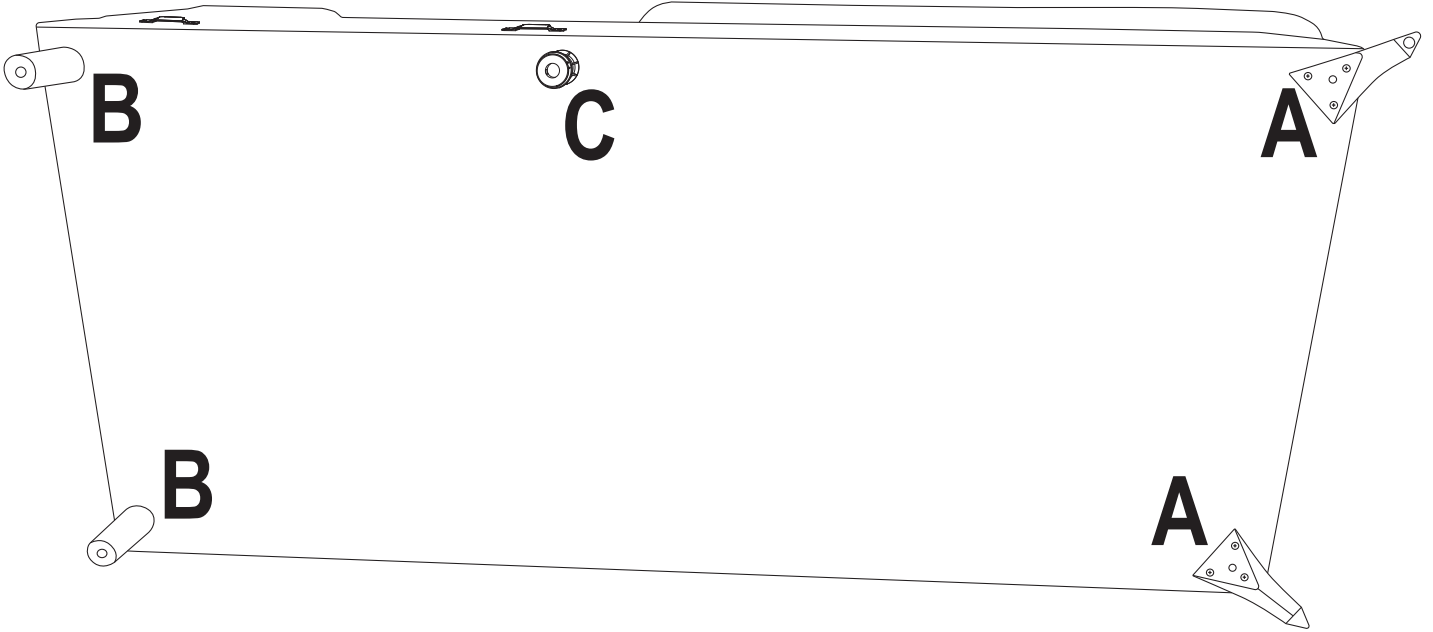
H=90-140 mm

Dx6

5x25
PZ2

Ex2

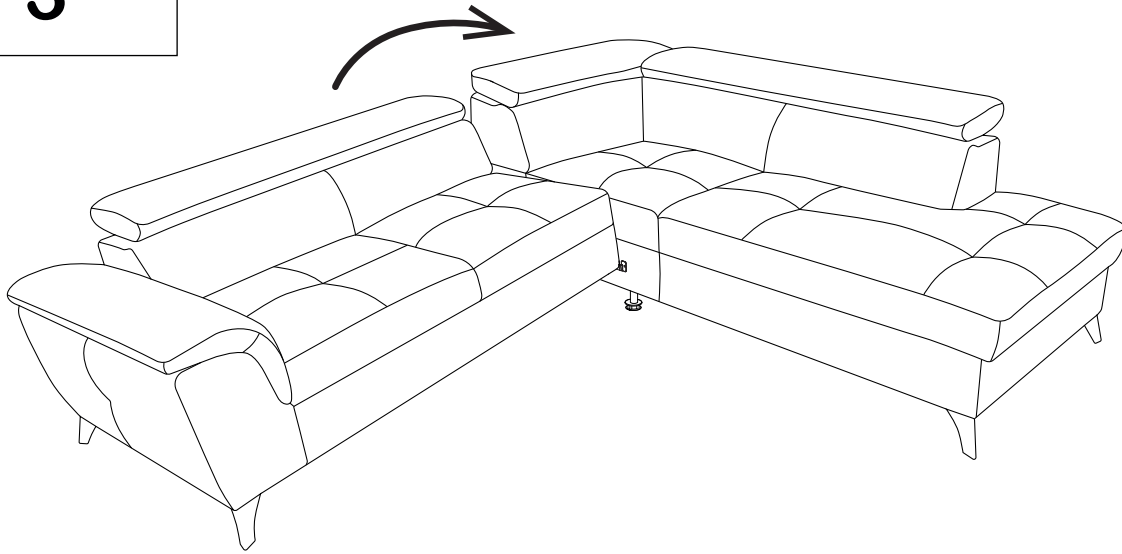
8x25



3

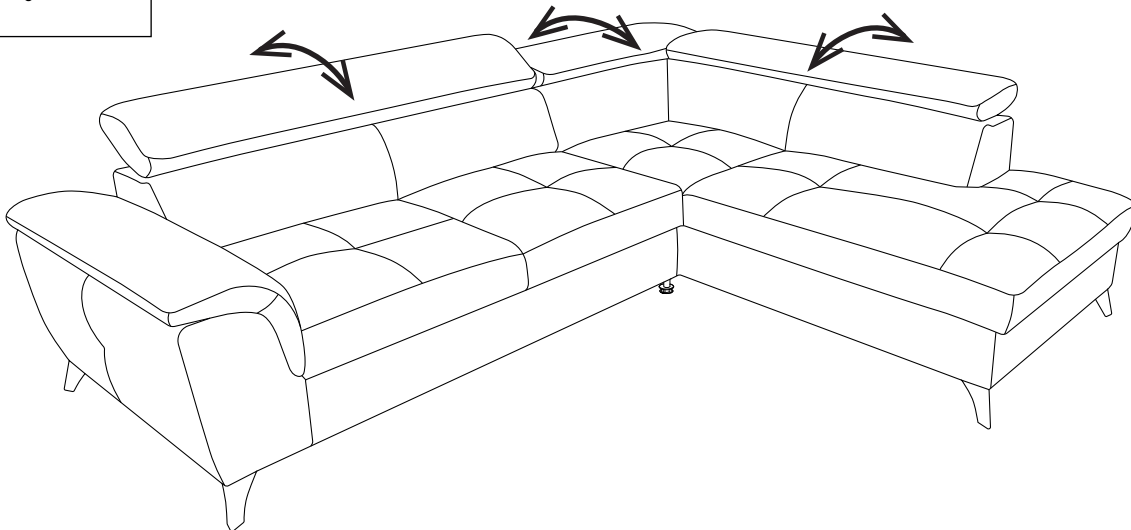

4



5

